

STATE OF NORTH CAROLINA
DEPARTMENT OF TRANSPORTATION
HIGHWAY DIVISION 6

PROPOSAL

ANNUAL RENEWABLE - 3 YEARS

DATE AND TIME OF BID OPENING: JUNE 16, 2021 AT 2:00 PM
CONTRACT ID: D6BR.POC.019
TIP No.: -----
FEDERAL AID NO.: STATE FUNDED
WBS ELEMENT NO.: 6BPR.10091, ETC.
ROUTE NO.: VARIOUS PRIMARY & SR
LOCATION: VARIOUS
COUNTY: DIVISION WIDE
(BLADEN, COLUMBUS, CUMBERLAND, HARNETT & ROBESON)
TYPE OF WORK: REPAIR & REPLACEMENT OF BRIDGE EXPANSION JOINTS
LENGTH OF PROJECT: VARIOUS

NOTICE:

ALL BIDDERS SHALL COMPLY WITH ALL APPLICABLE LAWS REGULATING THE PRACTICE OF GENERAL CONTRACTING AS CONTAINED IN CHAPTER 87 OF THE GENERAL STATUTES OF NORTH CAROLINA WHICH REQUIRES THE BIDDER TO BE LICENSED BY THE N.C. LICENSING BOARD FOR CONTRACTORS WHEN BIDDING ON ANY NON-FEDERAL AID PROJECT WHERE THE BID IS \$30,000 OR MORE, EXCEPT FOR CERTAIN SPECIALTY WORK AS DETERMINED BY THE LICENSING BOARD. BIDDERS SHALL ALSO COMPLY WITH ALL OTHER APPLICABLE LAWS REGULATING THE PRACTICES OF ELECTRICAL, PLUMBING, HEATING AND AIR CONDITIONING AND REFRIGERATION CONTRACTING AS CONTAINED IN CHAPTER 87 OF THE GENERAL STATUTES OF NORTH CAROLINA. NOTWITHSTANDING THESE LIMITATIONS ON BIDDING, THE BIDDER WHO IS AWARDED ANY FEDERAL - AID FUNDED PROJECT SHALL COMPLY WITH CHAPTER 87 OF THE GENERAL STATUTES OF NORTH CAROLINA FOR LICENSING REQUIREMENTS WITHIN 60 CALENDAR DAYS OF BID OPENING.

THIS IS A ROADWAY PROJECT.

BID BONDS ARE NOT REQUIRED.

NAME OF BIDDER

ADDRESS OF BIDDER

NC GENERAL CONTRACTOR'S LICENSE NO. (If Applicable)

NORTH CAROLINA
DEPARTMENT OF TRANSPORTATION
RALEIGH, NORTH CAROLINA

The Bidder has carefully examined the location of the proposed work; has carefully examined the plans and specifications, which are acknowledged to be part of the proposal, the special provisions, the proposal, the form of contract, and the forms of contract payment bond and contract performance bond; and thoroughly understands the stipulations, requirements and provisions. The undersigned bidder agrees to bound upon his execution of the bid and subsequent award to him by the Department of Transportation in accordance with this proposal to provide the necessary contract payment bond and contract performance bond within fourteen days after the written notice of award is received by him. The undersigned Bidder further agrees to provide all necessary machinery, tools, labor, and other means of construction; and to do all the work and to furnish all materials, except as otherwise noted, necessary to perform and complete the said contract in accordance with *the 2018 Standard Specifications for Roads and Structures* by the date(s) specified in the Project Special Provisions and in accordance with the requirements of the Engineer, and at the unit or lump sum prices, as the case may be, for the various items given on the sheets contained herein.

The Bidder shall provide and furnish all the materials, machinery, implements, appliances and tools, and perform the work and required labor to construct and complete this contract, for the unit or lump sum prices, as the case may be, bid by the Bidder in his bid and according to the proposal, plans, and specifications prepared by said Department, which proposal, plans, and specifications show the details covering this project, and hereby become a part of this contract.

The published volume entitled *North Carolina Department of Transportation, Raleigh, Standard Specifications for Roads and Structures, January 2018* with all amendments and supplements thereto, is by reference incorporated into and made a part of this contract; that, except as herein modified, all the construction and work included in this contract is to be done in accordance with the specifications contained in said volume, and amendments and supplements thereto, under the direction of the Engineer.

If the proposal is accepted and the award is made, the contract is valid only when signed either by the Contract Officer or such other person as may be designated by the Secretary to sign for the Department of Transportation. The conditions and provisions herein cannot be changed except over the signature of the said Contract Officer or Division Engineer.

The quantities shown in the itemized proposal for the project are considered to be approximate only and are given as the basis for comparison of bids. The Department of Transportation may increase or decrease the quantity of any item or portion of the work as may be deemed necessary or expedient.

An increase or decrease in the quantity of an item will not be regarded as sufficient ground for an increase or decrease in the unit prices, nor in the time allowed for the completion of the work, except as provided for the contract.

TABLE OF CONTENTS

COVER SHEET C-1

PROPOSAL SHEET C-2

TABLE OF CONTENTS C-3

INSTRUCTIONS TO BIDDERS C-4

PROJECT SPECIAL PROVISIONS..... G-1

STANDARD SPECIAL PROVISIONS SSP-1

UNIT PROJECT SPECIAL PROVISIONS

ROADWAY R-1

TRAFFIC CONTROL TC-1

SUBCONTRACTOR FORM..... SUB-1

EXECUTION OF BID FORMS EB-1

ACCEPTANCE SHEET..... ACC-1

ADDENDUM ACKNOWLEDGEMENTS..... ADD-1

PROPOSAL ITEMS SHEETPIF-1

INSTRUCTIONS TO BIDDERS

PLEASE READ ALL INSTRUCTIONS CAREFULLY BEFORE PREPARING AND SUBMITTING YOUR BID.

All bids shall be prepared and submitted in accordance with the following requirements. Failure to comply with any requirement may cause the bid to be considered irregular and may be grounds for rejection of the bid.

TRADITIONAL PAPER BIDS:

1. Download the entire proposal from the **Connect NCDOT website** and **return the entire proposal with your bid.**
2. All entries on the itemized proposal sheet (bid form) shall be written in ink or typed.
3. The Bidder shall submit a unit price for every item on the itemized proposal sheet. The unit prices for the various contract items shall be written in figures. Unit prices shall be rounded off by the Bidder to contain no more than FOUR decimal places.
4. An amount bid shall be entered on the itemized proposal sheet for every item. The amount bid for each item shall be determined by multiplying each unit bid by the quantity for that item, and shall be written in figures in the "Amount" column of the form.
5. The total amount bid shall be written in figures in the proper place on the bid form. The total amount bid shall be determined by adding the amounts bid for each item.
6. Changes to any entry shall be made by marking through the entry in ink and making the correct entry adjacent thereto in ink. A representative of the Bidder shall initial the change in ink. Do not use correction fluid, correction tape or similar product to make corrections.
7. The bid shall be properly executed on the included **Execution of Bid – Non-collusion Affidavit, Debarment Certification and Gift Ban Certification** form. All bids shall show the following information:
 - a. Name of corporation, partnership, Limited Liability Company, joint venture, individual or firm, submitting bid.
Corporations that have a corporate seal should include it on the bid.
 - b. Name of individual or representative submitting bid and position or title held on behalf of the bidder.
 - c. Name, signature, and position or title of witness.
8. The bid shall not contain any unauthorized additions, deletions, or conditional bids.
9. The Bidder shall not add any provision reserving the right to accept or reject an award, or to enter into a contract pursuant to an award.
10. **THE PROPOSAL WITH THE ITEMIZED PROPOSAL SHEET ATTACHED SHALL BE PLACED IN A SEALED ENVELOPE AND SHALL BE DELIVERED TO AND RECEIVED IN THE NCDOT DIVISION PROPOSALS ENGINEER'S OFFICE AT 1194 PRISON CAMP ROAD, WHITEVILLE, N. C. 28472 BY 2:00 P.M., ON WEDNESDAY, JUNE 16, 2021.**
11. **The sealed bid envelope must display the bidding Contractor's name and address on the front.**
12. The sealed bid must display the following statement on the front of the sealed envelope:

**QUOTATION FOR D6BR.POC.019 – DIVISION 6
REPAIR & REPLACEMENT OF BRIDGE EXPANSION JOINTS
TO BE OPENED AT 2:00 PM ON JUNE 16, 2021**

13. Bid packages should be delivered to the Division Proposals Engineer's office prior to the bid opening deadline listed above, either by hand or express delivery.
14. Bid packages should not be sent through the US Post Office by regular US Mail. Regular US Mail does not guarantee delivery by any certain day or time, and may result in your bid package arriving late. NCDOT is not responsible for ensuring your bid package arrives on time.
15. **Any bid package received after the designated bid opening deadline, for any reason, shall be considered non-responsive, will not be opened and read, and will be destroyed or returned.**

BID OPENING & PUBLIC READING:

1. At the designated day and time, all bids submitted will be opened, read aloud and recorded, with a witness in attendance.
2. Bid opening will be conducted in the NCDOT Whiteville District conference room, and will be open to the public.

PROJECT SPECIAL PROVISIONS

GENERAL

This contract is for as needed (On Call) Repair and/or Replacement of Bridge Expansion Joints in the NC Department of Transportation's Division 6. This Division is made up of the following counties: Bladen, Columbus, Cumberland, Harnett, & Robeson.

All work and materials shall be in accordance with the provisions of the General Guidelines of this contract, the Project Special Provisions, the North Carolina Department of Transportation Standard Specifications for Roads and Structures 2018, the North Carolina Department of Transportation Roadway Standards Drawings, and the current edition of the Manual of Uniform Traffic Control Devices (MUTCD). The Contractor shall keep himself fully informed of all Federal, State and local laws, ordinances, and regulations, and shall comply with the provisions of Section 107 of the Standard Specifications.

DIVISION CONTACT:

The Bridge Maintenance contact will be Mr. Darren K. Pittman - Bridge Maintenance Engineer, and he may be reached at (910) 364-0670.

CONTRACTORS LICENSE AND CERTIFICATION:

This type of construction and installation is considered specialty work, and defined as "Highway Road and Bridge Maintenance Activities" for NCDOT. Therefore, the requirement for a NC General Contractor's license is waived.

CONTRACT TIME AND LIQUIDATED DAMAGES:

(7-1-95) (Rev. 12-18-07)

SP1 G10 A

The date of availability for this contract is **July 1, 2021**.

The completion date for this contract is **June 30, 2022**.

Except where otherwise provided by the contract, observation periods required by the contract will not be a part of the work to be completed by the completion date and/or intermediate contract times stated in the contract. The acceptable completion of the observation periods that extend beyond the final completion date shall be a part of the work covered by the performance and payment bonds.

The liquidated damages for this contract are **Seven Hundred Dollars (\$ 700.00)** per calendar day.

INTERMEDIATE CONTRACT TIME AND LIQUIDATED DAMAGES:

(2-20-07)

SP1G14A

The Contractor shall complete the required work of installing, maintaining, and removing the traffic control devices for lane closures and restoring traffic to the existing traffic pattern. The Contractor shall not close or narrow a lane of traffic on **ANY ROAD** during the following time restrictions:

DAY AND TIME RESTRICTIONS

TO BE DETERMINED BY NCDOT BRIDGE ENGINEER

In addition, the Contractor shall not narrow or close a lane of traffic on **ANY ROAD**, detain and /or alter the traffic flow on or during holiday weekends, special events, or any other time when traffic is unusually heavy, including the following schedules:

HOLIDAY AND HOLIDAY WEEKEND LANE CLOSURE RESTRICTIONS

1. For unexpected occurrence that creates unusually high traffic volumes, as directed by the Engineer.
2. For New Year's Day, between the hours of 6:00 a.m. December 31st and 9:00 p.m. January 2nd. If New Year's Day is on a Friday, Saturday, Sunday or Monday, then until 7:00 p.m. the following Tuesday.
3. For Easter, between the hours of 6:00 a.m. Thursday and 7:00 p.m. Monday.
4. For Memorial Day, between the hours of 6:00 a.m. Friday and 7:00 p.m. Tuesday.
5. For Independence Day, between the hours of 6:00 a.m. the day before Independence Day and 7:00 p.m. the day after Independence Day.

If Independence Day is on a Friday, Saturday, Sunday or Monday, then between the hours of 6:00 a.m. the Thursday before Independence Day and 7:00 p.m. the Tuesday after Independence Day.

6. For Labor Day, between the hours of 6:00 a.m. Friday and 7:00 p.m. Tuesday.
7. For Thanksgiving Day, between the hours of 6:00 a.m. Tuesday and 7:00 p.m. Monday.
8. For Christmas, between the hours of 6:00 a.m. the Friday before the week of Christmas Day and 7:00 p.m. the following Tuesday after the week of Christmas Day.

Holidays and holiday weekends shall include New Year's, Easter, Memorial Day, Independence Day, Labor Day, Thanksgiving, and Christmas. The Contractor shall schedule his work so that lane closures are not required during these periods, unless otherwise directed by the Engineer.

The time of availability for this intermediate contract work shall be the time the Contractor begins to install all traffic control devices for lane closures according to the time restrictions listed herein.

The completion time for this intermediate contract work shall be the time the Contractor is required to complete the removal of all traffic control devices for lane closures according to the time restrictions stated herein and place traffic in the existing traffic pattern.

The liquidated damages are **Two Hundred Fifty Dollars (\$ 250.00)** per hour.

BIDS OVER LIMIT:

(08-01-16)

SPD 01-400

In accordance with GS 136-28.1(b), if the total bid amount of the contract exceeds \$5.0 million, the bid will not be considered for award.

DIVISION LET CONTRACT PREQUALIFICATION:

(07-01-14)(12-1-16)

SPD 01-410

Any firm that wishes to bid as a prime contractor shall be prequalified as a Bidder or PO Prime Contractor prior to submitting a bid. Information regarding prequalification can be found at:

<https://connect.ncdot.gov/business/Prequal/Pages/default.aspx>.

Prior to performing the work, the prime contractor and/or subcontractor(s) shall be prequalified in the work code(s) which are identified as work items in the prime contractor’s construction progress schedule that they will complete themselves. Any contractor identified as working outside their expertise may be considered in default of contract.

BOND REQUIREMENTS – No Bonds Required

(06-01-16)

SPD 01-420B

The provisions of Articles 102-10 and 103-7 of the *2018 Standard Specifications for Roads and Structures* are waived for this project. No bonds required.

AUTHORITY OF THE ENGINEER:

(01-30-14)

105-1

SPD 01-460

The Engineer for this project shall be the Division Engineer, Division 6, Division of Highways, North Carolina Department of Transportation, acting directly or through his duly authorized representative.

The Engineer will decide all questions which may arise as to the quality and acceptability of work performed and as to the rate of progress of the work; all questions which may arise as to the interpretation of the contract; and all questions as to the acceptable fulfillment of the contract on the part of the Contractor. His decision shall be final and he shall have executive authority to enforce and make effective such decisions and orders as the Contractor fails to carry them out promptly.

NO MAJOR CONTRACT ITEMS:

(2-19-02) (Rev. 8-21-07)

104

SP1 G31

None of the items included in this contract will be major items.

NO SPECIALTY ITEMS:

(7-1-95)

108-6

SP1 G34

None of the items included in this contract will be specialty items (see Article 108-6 of the *2018 Standard Specifications*).

MINORITY BUSINESS ENTERPRISE AND WOMEN BUSINESS ENTERPRISE (DIVISIONS):

(10-16-07)(Rev. 2-19-19)

102-15(J)

SP1 G67

Description

The purpose of this Special Provision is to carry out the North Carolina Department of Transportation’s policy of ensuring nondiscrimination in the award and administration of contracts financed in whole or in part with State funds.

Definitions

Additional MBE/WBE Subcontractors - Any MBE/WBE submitted at the time of bid that will not be used to meet the Combined MBE/WBE goal. No submittal of a Letter of Intent is required.

Combined MBE/WBE Goal: A portion of the total contract, expressed as a percentage that is to be performed by committed MBE/WBE subcontractors.

Committed MBE/WBE Subcontractor - Any MBE/WBE submitted at the time of bid that is being used to meet the Combined MBE / WBE goal by submission of a Letter of Intent. Or any MBE or WBE used as a replacement for a previously committed MBE or WBE firm.

Contract Goal Requirement - The approved participation at time of award, but not greater than the advertised Combined MBE/WBE contract goal.

Goal Confirmation Letter - Written documentation from the Department to the bidder confirming the Contractor's approved, committed participation along with a listing of the committed MBE and WBE firms.

Manufacturer - A firm that operates or maintains a factory or establishment that produces on the premises, the materials or supplies obtained by the Contractor.

MBE Participation (Anticipated) - A portion of the total contract, expressed as a percentage that is anticipated to be performed by committed MBE subcontractor(s).

Minority Business Enterprise (MBE) - A firm certified as a Disadvantaged Minority-Owned Business Enterprise through the North Carolina Unified Certification Program.

Regular Dealer - A firm that owns, operates, or maintains a store, warehouse, or other establishment in which the materials or supplies required for the performance of the contract are bought, kept in stock, and regularly sold to the public in the usual course of business. A regular dealer engages in, as its principal business and in its own name, the purchase and sale or lease of the products in question. A regular dealer in such bulk items as steel, cement, gravel, stone, and petroleum products need not keep such products in stock, if it owns and operates distribution equipment for the products. Brokers and packagers are not regarded as manufacturers or regular dealers within the meaning of this section.

Replacement / Substitution – A full or partial reduction in the amount of work subcontracted to a committed (or an approved substitute) MBE/WBE firm.

North Carolina Unified Certification Program (NCUCP) - A program that provides comprehensive services and information to applicants for MBE/WBE certification. The MBE/WBE program follows the same regulations as the federal Disadvantaged Business Enterprise (DBE) program in accordance with 49 CFR Part 26.

United States Department of Transportation (USDOT) - Federal agency responsible for issuing regulations (49 CFR Part 26) and official guidance for the DBE program.

WBE Participation (Anticipated) - A portion of the total contract, expressed as a percentage that is anticipated to be performed by committed WBE subcontractor(s).

Women Business Enterprise (WBE) - A firm certified as a Disadvantaged Women-Owned Business Enterprise through the North Carolina Unified Certification Program.

Forms and Websites Referenced in this Provision

Payment Tracking System - On-line system in which the Contractor enters the payments made to MBE and WBE subcontractors who have performed work on the project.

<https://apps.dot.state.nc.us/Vendor/PaymentTracking/>

DBE-IS Subcontractor Payment Information - Form for reporting the payments made to all MBE/WBE firms working on the project. This form is for paper bid projects only.

<https://connect.ncdot.gov/business/Turnpike/Documents/Form%20DBE-IS%20Subcontractor%20Payment%20Information.pdf>

RF-1 MBE/WBE Replacement Request Form - Form for replacing a committed MBE or WBE.

<http://connect.ncdot.gov/projects/construction/Construction%20Forms/DBE%20MBE%20WBE%20Replacement%20Request%20Form.pdf>

SAF Subcontract Approval Form - Form required for approval to sublet the contract.

<http://connect.ncdot.gov/projects/construction/Construction%20Forms/Subcontract%20Approval%20Form%20Rev.%202012.zip>

JC-1 Joint Check Notification Form - Form and procedures for joint check notification. The form acts as a written joint check agreement among the parties providing full and prompt disclosure of the expected use of joint checks.

<http://connect.ncdot.gov/projects/construction/Construction%20Forms/Joint%20Check%20Notification%20Form.pdf>

Letter of Intent - Form signed by the Contractor and the MBE/WBE subcontractor, manufacturer or regular dealer that affirms that a portion of said contract is going to be performed by the signed MBE/WBE for the estimated amount (based on quantities and unit prices) listed at the time of bid.

<http://connect.ncdot.gov/letting/LetCentral/Letter%20of%20Intent%20to%20Perform%20as%20a%20Subcontractor.pdf>

Listing of MBE and WBE Subcontractors Form - Form for entering MBE/WBE subcontractors on a project that will meet the Combined MBE/WBE goal. This form is for paper bids only.

[http://connect.ncdot.gov/municipalities/Bid%20Proposals%20for%20LGA%20Content/09%20MBE-WBE%20Subcontractors%20\(State\).docx](http://connect.ncdot.gov/municipalities/Bid%20Proposals%20for%20LGA%20Content/09%20MBE-WBE%20Subcontractors%20(State).docx)

Subcontractor Quote Comparison Sheet - Spreadsheet for showing all subcontractor quotes in the work areas where MBEs and WBEs quoted on the project. This sheet is submitted with good faith effort packages.

<http://connect.ncdot.gov/business/SmallBusiness/Documents/DBE%20Subcontractor%20Quote%20Comparison%20Example.xls>

Combined MBE/WBE Goal

The Combined MBE/WBE Goal for this project is **0.0 %**

The Combined Goal was established utilizing the following anticipated participation for Minority Business Enterprises and Women Business Enterprises:

(A) Minority Business Enterprises **0.0 %**

- (1) *If the anticipated MBE participation is more than zero, the Contractor shall exercise all necessary and reasonable steps to ensure that MBEs participate in at least the percent of the contract as set forth above.*
- (2) *If the anticipated MBE participation is zero, the Contractor shall make an effort to recruit and use MBEs during the performance of the contract. Any MBE participation obtained shall be reported to the Department.*

(B) Women Business Enterprises **0.0 %**

- (1) *If the anticipated WBE participation is more than zero, the Contractor shall exercise all necessary and reasonable steps to ensure that WBEs participate in at least the percent of the contract as set forth above.*
- (2) *If the anticipated WBE participation is zero, the Contractor shall make an effort to recruit and use WBEs during the performance of the contract. Any WBE participation obtained shall be reported to the Department.*

The Bidder is required to submit only participation to meet the Combined MBE/WBE Goal. The Combined Goal may be met by submitting all MBE participation, all WBE participation, or a combination of MBE and WBE participation.

Directory of Transportation Firms (Directory)

Real-time information is available about firms doing business with the Department and firms that are certified through NCUCP in the Directory of Transportation Firms. Only firms identified in the Directory as MBE and WBE certified shall be used to meet the Combined MBE / WBE goal. The Directory can be found at the following link. <https://www.ebs.nc.gov/VendorDirectory/default.html>

The listing of an individual firm in the directory shall not be construed as an endorsement of the firm's capability to perform certain work.

Listing of MBE/WBE Subcontractors

At the time of bid, bidders shall submit all MBE and WBE participation that they anticipate to use during the life of the contract. Only those identified to meet the Combined MBE/WBE goal will be considered committed, even though the listing shall include both committed MBE/WBE subcontractors and additional MBE/WBE subcontractors. Any additional MBE/WBE subcontractor participation above the goal will follow the banking guidelines found elsewhere in this provision. All other additional MBE/WBE subcontractor participation submitted at the time of bid will be used toward the Department's overall race-neutral goals. Only those firms with current MBE and WBE certification at the time of bid

opening will be acceptable for listing in the bidder's submittal of MBE and WBE participation. The Contractor shall indicate the following required information:

(A) Electronic Bids

Bidders shall submit a listing of MBE and WBE participation in the appropriate section of the electronic submittal file.

- (1) Submit the names and addresses of MBE and WBE firms identified to participate in the contract. If the bidder uses the updated listing of MBE and WBE firms shown in the electronic submittal file, the bidder may use the dropdown menu to access the name and address of the firms.
- (2) Submit the contract line numbers of work to be performed by each MBE and WBE firm. When no figures or firms are entered, the bidder will be considered to have no MBE or WBE participation.
- (3) The bidder shall be responsible for ensuring that the MBE and WBE are certified at the time of bid by checking the Directory of Transportation Firms. If the firm is not certified at the time of the bid-letting, that MBE's or WBE's participation will not count towards achieving the Combined MBE/WBE goal.

(B) Paper Bids

- (1) *If the Combined MBE/ WBE goal is more than zero,*
 - (a) Bidders, at the time the bid proposal is submitted, shall submit a listing of MBE/WBE participation, including the names and addresses on *Listing of MBE and WBE Subcontractors* contained elsewhere in the contract documents in order for the bid to be considered responsive. Bidders shall indicate the total dollar value of the MBE and WBE participation for the contract.
 - (b) If bidders have no MBE or WBE participation, they shall indicate this on the *Listing of MBE and WBE Subcontractors* by entering the word "None" or the number "0." This form shall be completed in its entirety. **Blank forms will not be deemed to represent zero participation.** Bids submitted that do not have MBE and WBE participation indicated on the appropriate form will not be read publicly during the opening of bids. The Department will not consider these bids for award and the proposal will be rejected.
 - (c) The bidder shall be responsible for ensuring that the MBE/WBE is certified at the time of bid by checking the Directory of Transportation Firms. If the firm is not certified at the time of the bid-letting, that MBE's or WBE's participation will not count towards achieving the Combined MBE/WBE goal.
- (2) *If the Combined MBE/WBE Goal is zero,* entries on the *Listing of MBE and WBE Subcontractors* are not required for the zero goal, however any MBE or WBE participation that is achieved during the project shall be reported in accordance with requirements contained elsewhere in the special provision.

MBE or WBE Prime Contractor

When a certified MBE or WBE firm bids on a contract that contains a Combined MBE/WBE Goal, the firm is responsible for meeting the goal or making good faith efforts to meet the goal, just like any other bidder. In most cases, a MBE or WBE bidder on a contract will meet the Combined MBE/WBE goal by virtue of the work it performs on the contract with its own forces. However, all the work that is performed by the MBE or WBE bidder and any other similarly certified subcontractors will count toward the goal. The MBE or WBE bidder shall list itself along with any MBE or WBE subcontractors, if any, in order to receive credit toward the goals.

MBE/WBE prime contractors shall also follow Sections A or B listed under *Listing of MBE/WBE Subcontractors* just as a non-MBE/WBE bidder would.

Written Documentation – Letter of Intent

The bidder shall submit written documentation for each MBE/WBE that will be used to meet the Combined MBE/WBE goal of the contract, indicating the bidder's commitment to use the MBE/WBE in the contract. This documentation shall be submitted on the Department's form titled *Letter of Intent*.

The documentation shall be received in the office of the Engineer no later than 2:00 p.m. of the fifth calendar day following opening of bids, unless the fifth day falls on Saturday, Sunday or an official state holiday. In that situation, it is due in the office of the Engineer no later than 10:00 a.m. on the next official state business day.

If the bidder fails to submit the Letter of Intent from each committed MBE and WBE to be used toward the Combined MBE/WBE goal, or if the form is incomplete (i.e. both signatures are not present), the MBE/WBE participation will not count toward meeting the Combined MBE/WBE goal. If the lack of this participation drops the commitment below the Combined MBE/WBE goal, the Contractor shall submit evidence of good faith efforts for the goal not met, completed in its entirety, to the Engineer no later than 2:00 p.m. of the eighth calendar day following opening of bids, unless the eighth day falls on Saturday, Sunday or an official state holiday. In that situation, it is due in the office of the Engineer no later than 10:00 a.m. on the next official state business day.

Banking MBE/WBE Credit

If the committed MBE/WBE participation submitted exceeds the algebraic sum of the Combined MBE/WBE goal by \$1,000 or more, the excess will be placed on deposit by the Department for future use by the bidder. Separate accounts will be maintained for MBE and WBE participation and these may accumulate for a period not to exceed 24 months.

When the apparent lowest responsive bidder fails to submit sufficient participation by MBE and WBE firms to meet the advertised goal, as part of the good faith effort, the Department will consider allowing the bidder to withdraw funds to meet the Combined MBE/WBE goal as long as there are adequate funds available from the bidder's MBE and WBE bank accounts.

Submission of Good Faith Effort

If the bidder fails to meet or exceed the Combined MBE/WBE goal, the apparent lowest responsive bidder shall submit to the Department documentation of adequate good faith efforts made to reach that specific goal.

One complete set and 6 copies of this information shall be received in the office of the Engineer no later than 2:00 p.m. of the fifth calendar day following opening of bids, unless the fifth day falls on Saturday, Sunday or an official state holiday. In that situation, it is due in the office of the Engineer no later than 10:00 a.m. on the next official state business day.

Note: Where the information submitted includes repetitious solicitation letters, it will be acceptable to submit a representative letter along with a distribution list of the firms that were solicited. Documentation of MBE/WBE quotations shall be a part of the good faith effort submittal. This documentation may include written subcontractor quotations, telephone log notations of verbal quotations, or other types of quotation documentation.

Consideration of Good Faith Effort for Projects with a Combined MBE/WBE Goal More Than Zero

Adequate good faith efforts mean that the bidder took all necessary and reasonable steps to achieve the goal which, by their scope, intensity, and appropriateness, could reasonably be expected to obtain sufficient MBE/WBE participation. Adequate good faith efforts also mean that the bidder actively and aggressively sought MBE/WBE participation. Mere *pro forma* efforts are not considered good faith efforts.

The Department will consider the quality, quantity, and intensity of the different kinds of efforts a bidder has made. Listed below are examples of the types of actions a bidder will take in making a good faith effort to meet the goals and are not intended to be exclusive or exhaustive, nor is it intended to be a mandatory checklist.

- (A) Soliciting through all reasonable and available means (e.g. attendance at pre-bid meetings, advertising, written notices, use of verifiable electronic means through the use of the NCDOT Directory of Transportation Firms) the interest of all certified MBEs/WBEs that are also prequalified subcontractors. The bidder must solicit this interest within at least 10 days prior to bid opening to allow the MBEs/WBEs to respond to the solicitation. Solicitation shall provide the opportunity to MBEs/WBEs within the Division and surrounding Divisions where the project is located. The bidder must determine with certainty if the MBEs/WBEs are interested by taking appropriate steps to follow up initial solicitations.
- (B) Selecting portions of the work to be performed by MBEs/WBEs in order to increase the likelihood that the Combined MBE/WBE goal will be achieved.
 - (1) Where appropriate, break out contract work items into economically feasible units to facilitate MBE/WBE participation, even when the prime contractor might otherwise prefer to perform these work items with its own forces.
 - (2) Negotiate with subcontractors to assume part of the responsibility to meet the advertised goal when the work to be sublet includes potential for MBE/WBE participation (2nd and 3rd tier subcontractors).
- (C) Providing interested certified MBEs/WBEs that are also prequalified subcontractors with adequate information about the plans, specifications, and requirements of the contract in a timely manner to assist them in responding to a solicitation.
- (D) (1) Negotiating in good faith with interested MBEs/WBEs. It is the bidder's

responsibility to make a portion of the work available to MBE/WBE subcontractors and suppliers and to select those portions of the work or material needs consistent with the available MBE/WBE subcontractors and suppliers, so as to facilitate MBE/WBE participation. Evidence of such negotiation includes the names, addresses, and telephone numbers of MBEs/WBEs that were considered; a description of the information provided regarding the plans and specifications for the work selected for subcontracting; and evidence as to why additional agreements could not be reached for MBEs/WBEs to perform the work.

- (2) A bidder using good business judgment would consider a number of factors in negotiating with subcontractors, including MBE/WBE subcontractors, and would take a firm's price and capabilities as well as the advertised goal into consideration. However, the fact that there may be some additional costs involved in finding and using MBEs/WBEs is not in itself sufficient reason for a bidder's failure to meet the advertised goal, as long as such costs are reasonable. Also, the ability or desire of a prime contractor to perform the work of a contract with its own organization does not relieve the bidder of the responsibility to make good faith efforts. Bidding contractors are not, however, required to accept higher quotes from MBEs/WBEs if the price difference is excessive or unreasonable.
- (E) Not rejecting MBEs/WBEs as being unqualified without sound reasons based on a thorough investigation of their capabilities. The bidder's standing within its industry, membership in specific groups, organizations, or associates and political or social affiliations (for example, union vs. non-union employee status) are not legitimate causes for the rejection or non-solicitation of bids in the bidder's efforts to meet the project goal.
- (F) Making efforts to assist interested MBEs/WBEs in obtaining bonding, lines of credit, or insurance as required by the recipient or bidder.
- (G) Making efforts to assist interested MBEs/WBEs in obtaining necessary equipment, supplies, materials, or related assistance or services.
- (H) Effectively using the services of available minority/women community organizations; minority/women contractors' groups; Federal, State, and local minority/women business assistance offices; and other organizations as allowed on a case-by-case basis to provide assistance in the recruitment and placement of MBEs/WBEs. Contact within 7 days from the bid opening the Business Opportunity and Work Force Development Unit at BOWD@ncdot.gov to give notification of the bidder's inability to get MBE or WBE quotes.
- (I) Any other evidence that the bidder submits which shows that the bidder has made reasonable good faith efforts to meet the advertised goal.

In addition, the Department may take into account the following:

- (1) Whether the bidder's documentation reflects a clear and realistic plan for achieving the Combined MBE/WBE goal.
- (2) The bidders' past performance in meeting the contract goal.
- (3) The performance of other bidders in meeting the advertised goal. For example, when the apparent successful bidder fails to meet the goal, but others meet it, you may reasonably raise the question of whether, with additional reasonable efforts the apparent successful

bidder could have met the goal. If the apparent successful bidder fails to meet the advertised goal, but meets or exceeds the average MBE and WBE participation obtained by other bidders, the Department may view this, in conjunction with other factors, as evidence of the apparent successful bidder having made a good faith effort.

If the Department does not award the contract to the apparent lowest responsive bidder, the Department reserves the right to award the contract to the next lowest responsive bidder that can satisfy to the Department that the Combined MBE/WBE goal can be met or that an adequate good faith effort has been made to meet the advertised goal.

Non-Good Faith Appeal

The Engineer will notify the contractor verbally and in writing of non-good faith. A contractor may appeal a determination of non-good faith made by the Goal Compliance Committee. If a contractor wishes to appeal the determination made by the Committee, they shall provide written notification to the Engineer. The appeal shall be made within 2 business days of notification of the determination of non-good faith.

Counting MBE/WBE Participation Toward Meeting the Combined MBE/WBE Goal

(A) Participation

The total dollar value of the participation by a committed MBE/WBE will be counted toward the contract goal requirements. The total dollar value of participation by a committed MBE/WBE will be based upon the value of work actually performed by the MBE/WBE and the actual payments to MBE/WBE firms by the Contractor.

(B) Joint Checks

Prior notification of joint check use shall be required when counting MBE/WBE participation for services or purchases that involves the use of a joint check. Notification shall be through submission of Form JC-1 (*Joint Check Notification Form*) and the use of joint checks shall be in accordance with the Department's Joint Check Procedures.

(C) Subcontracts (Non-Trucking)

A MBE/WBE may enter into subcontracts. Work that a MBE subcontracts to another MBE firm may be counted toward the anticipated MBE participation. The same holds for work that a WBE subcontracts to another WBE firm. Work that a MBE/WBE subcontracts to a non-MBE/WBE firm does not count toward the contract goal requirement. It should be noted that every effort shall be made by MBE and WBE contractors to subcontract to the same certification (i.e., MBEs to MBEs and WBEs to WBEs), in order to fulfill the MBE or WBE participation breakdown. This, however, may not always be possible due to the limitation of firms in the area. If the MBE or WBE firm shows a good faith effort has been made to reach out to similarly certified firms and there is no interest or availability, and they can get assistance from other certified firms, the Engineer will not hold the prime responsible for meeting the individual MBE or WBE breakdown. If a MBE or WBE contractor or subcontractor subcontracts a significantly greater portion of the work of the contract than would be expected on the basis of standard industry practices, it shall be presumed that the MBE or WBE is not performing a commercially useful function.

(D) Joint Venture

When a MBE or WBE performs as a participant in a joint venture, the Contractor may count toward its contract goal requirement a portion of the total value of participation with the MBE or WBE in the joint venture, that portion of the total dollar value being a distinct clearly defined portion of work that the MBE or WBE performs with its forces.

(E) Suppliers

A contractor may count toward its MBE /WBE requirement 60 percent of its expenditures for materials and supplies required to complete the contract and obtained from a MBE or WBE regular dealer and 100 percent of such expenditures from a MBE or WBE manufacturer.

(F) Manufacturers and Regular Dealers

A contractor may count toward its MBE /WBE requirement the following expenditures to MBE/WBE firms that are not manufacturers or regular dealers:

- (1) The fees or commissions charged by a MBE/WBE firm for providing a *bona fide* service, such as professional, technical, consultant, or managerial services, or for providing bonds or insurance specifically required for the performance of a DOT-assisted contract, provided the fees or commissions are determined to be reasonable and not excessive as compared with fees and commissions customarily allowed for similar services.
- (2) With respect to materials or supplies purchased from a MBE/WBE, which is neither a manufacturer nor a regular dealer, count the entire amount of fees or commissions charged for assistance in the procurement of the materials and supplies, or fees or transportation charges for the delivery of materials or supplies required on a job site (but not the cost of the materials and supplies themselves), provided the fees are determined to be reasonable and not excessive as compared with fees customarily allowed for similar services.

Commercially Useful Function

(A) MBE/WBE Utilization

The Contractor may count toward its contract goal requirement only expenditures to MBEs and WBEs that perform a commercially useful function in the work of a contract. A MBE/WBE performs a commercially useful function when it is responsible for execution of the work of the contract and is carrying out its responsibilities by actually performing, managing, and supervising the work involved. To perform a commercially useful function, the MBE/WBE shall also be responsible with respect to materials and supplies used on the contract, for negotiating price, determining quality and quantity, ordering the material and installing (where applicable) and paying for the material itself. To determine whether a MBE/WBE is performing a commercially useful function, the Department will evaluate the amount of work subcontracted, industry practices, whether the amount the firm is to be paid under the contract is commensurate with the work it is actually performing and the MBE/WBE credit claimed for its performance of the work, and any other relevant factors. If it is determined that a MBE or WBE is not performing a Commercially Useful Function, the contractor may present evidence to rebut this presumption to the Department.

(B) MBE/WBE Utilization in Trucking

The following factors will be used to determine if a MBE or WBE trucking firm is performing a commercially useful function:

- (1) The MBE/WBE shall be responsible for the management and supervision of the entire trucking operation for which it is responsible on a particular contract, and there shall not be a contrived arrangement for the purpose of meeting the Combined MBE/WBE goal.
- (2) The MBE/WBE shall itself own and operate at least one fully licensed, insured, and operational truck used on the contract.
- (3) The MBE/WBE receives credit for the total value of the transportation services it provides on the contract using trucks it owns, insures, and operates using drivers it employs.
- (4) The MBE may subcontract the work to another MBE firm, including an owner-operator who is certified as a MBE. The same holds true that a WBE may subcontract the work to another WBE firm, including an owner-operator who is certified as a WBE. When this occurs, the MBE or WBE who subcontracts work receives credit for the total value of the transportation services the subcontracted MBE or WBE provides on the contract. It should be noted that every effort shall be made by MBE and WBE contractors to subcontract to the same certification (i.e., MBEs to MBEs and WBEs to WBEs), in order to fulfill the participation breakdown. This, however, may not always be possible due to the limitation of firms in the area. If the MBE or WBE firm shows a good faith effort has been made to reach out to similarly certified transportation service providers and there is no interest or availability, and they can get assistance from other certified providers, the Engineer will not hold the prime responsible for meeting the individual MBE or WBE participation breakdown.
- (5) The MBE/WBE may also subcontract the work to a non-MBE/WBE firm, including from an owner-operator. The MBE/WBE who subcontracts the work to a non-MBE/WBE is entitled to credit for the total value of transportation services provided by the non-MBE/WBE subcontractor not to exceed the value of transportation services provided by MBE/WBE-owned trucks on the contract. Additional participation by non-MBE/WBE subcontractors receives credit only for the fee or commission it receives as a result of the subcontract arrangement. The value of services performed under subcontract agreements between the MBE/WBE and the Contractor will not count towards the MBE/WBE contract requirement.
- (6) A MBE/WBE may lease truck(s) from an established equipment leasing business open to the general public. The lease must indicate that the MBE/WBE has exclusive use of and control over the truck. This requirement does not preclude the leased truck from working for others during the term of the lease with the consent of the MBE/WBE, so long as the lease gives the MBE/WBE absolute priority for use of the leased truck. This type of lease may count toward the MBE/WBE's credit as long as the driver is under the MBE/WBE's payroll.
- (7) Subcontracted/leased trucks shall display clearly on the dashboard the name of the MBE/WBE that they are subcontracted/leased to and their own company name if it is not identified on the truck itself. Magnetic door signs are not permitted.

MBE/WBE Replacement

When a Contractor has relied on a commitment to a MBE or WBE subcontractor (or an approved substitute MBE or WBE subcontractor) to meet all or part of a contract goal requirement, the contractor shall not terminate the MBE/WBE subcontractor for convenience. This includes, but is not limited to, instances in which the Contractor seeks to perform the work of the terminated subcontractor with another MBE/WBE subcontractor, a non-MBE/WBE subcontractor, or with the Contractor's own forces or those of an affiliate.

The Contractor must give notice in writing both by certified mail and email to the MBE/WBE subcontractor, with a copy to the Engineer of its intent to request to terminate and/or substitute, and the reason for the request. The Contractor must give the MBE/WBE subcontractor five (5) business days to respond to the Contractor's Notice of Intent to Request Termination and/or Substitution. If the MBE/WBE subcontractor objects to the intended termination/substitution, the MBE/WBE, within five (5) business days must advise the Contractor and the Department of the reasons why the action should not be approved. The five-day notice period shall begin on the next business day after written notice is provided to the MBE/WBE subcontractor.

A committed MBE/WBE subcontractor may only be terminated after receiving the Department's written approval based upon a finding of good cause for the proposed termination and/or substitution. For purposes of this section, good cause shall include the following circumstances:

- (a) The listed MBE/WBE subcontractor fails or refuses to execute a written contract;
- (b) The listed MBE/WBE subcontractor fails or refuses to perform the work of its subcontract in a way consistent with normal industry standards. Provided, however, that good cause does not exist if the failure or refusal of the MBE/WBE subcontractor to perform its work on the subcontract results from the bad faith or discriminatory action of the prime contractor;
- (c) The listed MBE/WBE subcontractor fails or refuses to meet the prime contractor's reasonable, nondiscriminatory bond requirements;
- (d) The listed MBE/WBE subcontractor becomes bankrupt, insolvent, or exhibits credit unworthiness;
- (e) The listed MBE/WBE subcontractor is ineligible to work on public works projects because of suspension and debarment proceedings pursuant to 2 CFR Parts 180, 215 and 1,200 or applicable state law;
- (f) The listed MBE/WBE subcontractor is not a responsible contractor;
- (g) The listed MBE/WBE voluntarily withdraws from the project and provides written notice of withdrawal;
- (h) The listed MBE/WBE is ineligible to receive MBE/WBE credit for the type of work required;
- (i) A MBE/WBE owner dies or becomes disabled with the result that the listed MBE/WBE contractor is unable to complete its work on the contract;
- (j) Other documented good cause that compels the termination of the MBE/WBE subcontractor. Provided, that good cause does not exist if the prime contractor seeks to terminate a MBE/WBE it relied upon to obtain the contract so that the prime contractor can self-perform the work for which the MBE/WBE contractor was engaged or so that the prime contractor can substitute another MBE/WBE or non-MBE/WBE contractor after contract award.

The Contractor shall comply with the following for replacement of a committed MBE/WBE:

(A) Performance Related Replacement

When a committed MBE/WBE is terminated for good cause as stated above, an additional MBE/WBE that was submitted at the time of bid may be used to fulfill the MBE/WBE commitment to meet the Combined MBE/WBE Goal. A good faith effort will only be required for removing a committed MBE/WBE if there were no additional MBE/WBEs submitted at the time of bid to cover the same amount of work as the MBE/WBE that was terminated.

If a replacement MBE/WBE is not found that can perform at least the same amount of work as the terminated MBE/WBE, the Contractor shall submit a good faith effort documenting the steps taken. Such documentation shall include, but not be limited to, the following:

- (1) Copies of written notification to MBE/WBEs that their interest is solicited in contracting the work defaulted by the previous MBE/WBE or in subcontracting other items of work in the contract.
- (2) Efforts to negotiate with MBE/WBEs for specific subbids including, at a minimum:
 - (a) The names, addresses, and telephone numbers of MBE/WBEs who were contacted.
 - (b) A description of the information provided to MBE/WBEs regarding the plans and specifications for portions of the work to be performed.
- (3) A list of reasons why MBE/WBE quotes were not accepted.
- (4) Efforts made to assist the MBE/WBEs contacted, if needed, in obtaining bonding or insurance required by the Contractor.

(B) Decertification Replacement

- (1) When a committed MBE/WBE is decertified by the Department after the SAF (*Subcontract Approval Form*) has been received by the Department, the Department will not require the Contractor to solicit replacement MBE/WBE participation equal to the remaining work to be performed by the decertified firm. The participation equal to the remaining work performed by the decertified firm will count toward the contract goal requirement.
- (2) When a committed MBE/WBE is decertified prior to the Department receiving the SAF (*Subcontract Approval Form*) for the named MBE/WBE firm, the Contractor shall take all necessary and reasonable steps to replace the MBE/WBE subcontractor with another MBE/WBE subcontractor to perform at least the same amount of work to meet the Combined MBE/WBE goal requirement. If a MBE/WBE firm is not found to do the same amount of work, a good faith effort must be submitted to NCDOT (see A herein for required documentation).

All requests for replacement of a committed MBE/WBE firm shall be submitted to the Engineer for approval on Form RF-1 (*DBE Replacement Request*). If the Contractor fails to follow this procedure, the Contractor may be disqualified from further bidding for a period of up to 6 months.

Changes in the Work

When the Engineer makes changes that result in the reduction or elimination of work to be performed by a committed MBE/WBE, the Contractor will not be required to seek additional participation. When the Engineer makes changes that result in additional work to be performed by a MBE/WBE based upon the Contractor's commitment, the MBE/WBE shall participate in additional work to the same extent as the MBE/WBE participated in the original contract work.

When the Engineer makes changes that result in extra work, which has more than a minimal impact on the contract amount, the Contractor shall seek additional participation by MBEs/WBEs unless otherwise approved by the Engineer.

When the Engineer makes changes that result in an alteration of plans or details of construction, and a portion or all of the work had been expected to be performed by a committed MBE/WBE, the Contractor shall seek participation by MBEs/WBEs unless otherwise approved by the Engineer.

When the Contractor requests changes in the work that result in the reduction or elimination of work that the Contractor committed to be performed by a MBE/WBE, the Contractor shall seek additional participation by MBEs/WBEs equal to the reduced MBE/WBE participation caused by the changes.

Reports and Documentation

A SAF (*Subcontract Approval Form*) shall be submitted for all work which is to be performed by a MBE/WBE subcontractor. The Department reserves the right to require copies of actual subcontract agreements involving MBE/WBE subcontractors.

When using transportation services to meet the contract commitment, the Contractor shall submit a proposed trucking plan in addition to the SAF. The plan shall be submitted prior to beginning construction on the project. The plan shall include the names of all trucking firms proposed for use, their certification type(s), the number of trucks owned by the firm, as well as the individual truck identification numbers, and the line item(s) being performed.

Within 30 calendar days of entering into an agreement with a MBE/WBE for materials, supplies or services, not otherwise documented by the SAF as specified above, the Contractor shall furnish the Engineer a copy of the agreement. The documentation shall also indicate the percentage (60% or 100%) of expenditures claimed for MBE/WBE credit.

Reporting Minority and Women Business Enterprise Participation

The Contractor shall provide the Engineer with an accounting of payments made to all MBE and WBE firms, including material suppliers and contractors at all levels (prime, subcontractor, or second tier subcontractor). This accounting shall be furnished to the Engineer for any given month by the end of the following month. Failure to submit this information accordingly may result in the following action:

- (A) Withholding of money due in the next partial pay estimate; or
- (B) Removal of an approved contractor from the prequalified bidders' list or the removal of other entities from the approved subcontractors list.

While each contractor (prime, subcontractor, 2nd tier subcontractor) is responsible for accurate accounting of payments to MBEs/WBEs, it shall be the prime contractor's responsibility to report all monthly and final payment information in the correct reporting manner.

Failure on the part of the Contractor to submit the required information in the time frame specified may result in the disqualification of that contractor and any affiliate companies from further bidding until the required information is submitted.

Failure on the part of any subcontractor to submit the required information in the time frame specified may result in the disqualification of that contractor and any affiliate companies from being approved for further work on future projects until the required information is submitted.

Contractors reporting transportation services provided by non-MBE/WBE lessees shall evaluate the value of services provided during the month of the reporting period only.

At any time, the Engineer can request written verification of subcontractor payments. The Contractor shall report the accounting of payments through the Department's DBE Payment Tracking System.

Failure to Meet Contract Requirements

Failure to meet contract requirements in accordance with Subarticle 102-15(J) of the *2018 Standard Specifications* may be cause to disqualify the Contractor.

CONTRACT PERIOD:

(2-19-14)

SPD 01-600

This contract shall be effective for one (1) contract period (12 months). At the option of the Department and upon agreement by the Contractor, this contract may be extended for up to two (2) additional one (1) year periods with a five percent (5%) increase in prices each year.

No changes in the terms, condition, etc. of this contract will be made when an extension of the contract is implemented. The Engineer will notify the Contractor in writing prior to renewal of the contract. The Contractor must notify the Engineer in writing within thirty (30) days of notification by the Engineer of his acceptance or rejection of this offer. Failure on the part of the Contractor to reply will be viewed as a rejection of the contract extension.

The Contractor shall provide an ACORD insurance certificate showing a minimum of \$5,000,000 Liability Insurance along with proof of all other legally required insurance.

MULTI-YEAR MAINTENANCE CONTRACTS:

(4-20-21)

SP1 G75

This contract is a multi-year maintenance contract let pursuant to the provisions of N.C. General Statute §136-28.1. In accordance with N.C. General Statute §136-28.1, an award in a maintenance contract shall not exceed \$5,000,000 per year. This contract award is limited to \$5,000,000 per year. No payments in excess of this amount will be disbursed, in accordance with the Statute.

EQUIPMENT IDLING GUIDELINES:

(1-19-21)

107

SP1 G096

Exercise reduced fuel consumption and reduced equipment emissions during the construction of all work associated with this contract. Employees engaged in the construction of this project should turn off vehicles when stopped for more than thirty (30) minutes and off-highway equipment should idle no longer than fifteen (15) consecutive minutes.

These guidelines for turning off vehicles and equipment when idling do not apply to:

1. Idling when queuing.
2. Idling to verify the vehicle is in safe operating condition.
3. Idling for testing, servicing, repairing or diagnostic purposes.
4. Idling necessary to accomplish work for which the vehicle was designed (such as operating a crane, mixing concrete, etc.).
5. Idling required to bring the machine system to operating temperature.
6. Emergency vehicles, utility company, construction, and maintenance vehicles where the engines must run to perform needed work.
7. Idling to ensure safe operation of the vehicle.
8. Idling when the propulsion engine is providing auxiliary power for other than heating or air conditioning. (such as hydraulic systems for pavers)
9. When specific traffic, safety, or emergency situations arise.
10. If the ambient temperature is less than 32 degrees Fahrenheit. Limited idling to provide for the safety of vehicle occupants (e.g. to run the heater).
11. If the ambient temperature is greater than 90 degrees Fahrenheit. Limited idling to provide for the safety of vehicle occupants of off-highway equipment (e.g. to run the air conditioning) no more than 30 minutes.
12. Diesel powered vehicles may idle for up to 30 minutes to minimize restart problems.

Any vehicle, truck, or equipment in which the primary source of fuel is natural gas or electricity is exempt from the idling limitations set forth in this special provision.

SUBSURFACE INFORMATION:

(7-1-95)

450

SP1 G112 A

There is **no** subsurface information available on this project. The Contractor shall make his own investigation of subsurface conditions.

PROSECUTION AND PROGRESS:

(3-16-10)

108

SPD 1-700

The Contractor shall pursue the work diligently with workmen in sufficient numbers, abilities, and supervision, and with equipment, materials, and methods as may be required to complete the work described in the contract by the completion date and in accordance with the *2018 Standard Specifications*.

The Contractor's operations are restricted to daylight hours on all routes except I-95. No work may be performed on weekends and legal State holidays, unless otherwise approved by the Engineer. Work shall only be performed when weather and visibility conditions allow safe operations.

TWELVE MONTH GUARANTEE:

(7-15-03)

108

SP1 G145

- (A) The Contractor shall guarantee materials and workmanship against latent and patent defects arising from faulty materials, faulty workmanship or negligence for a period of twelve months following the date of final acceptance of the work for maintenance and shall replace such defective materials and workmanship without cost to the Department. The Contractor will not be responsible for damage due to faulty design, normal wear and tear, for negligence on the part of the Department, and/or for use in excess of the design.
- (B) Where items of equipment or material carry a manufacturer's guarantee for any period in excess of twelve months, then the manufacturer's guarantee shall apply for that particular piece of equipment or material. The Department's first remedy shall be through the manufacturer although the Contractor is responsible for invoking the warranted repair work with the manufacturer. The Contractor's responsibility shall be limited to the term of the manufacturer's guarantee. NCDOT would be afforded the same warranty as provided by the Manufacturer.

This guarantee provision shall be invoked only for major components of work in which the Contractor would be wholly responsible for under the terms of the contract. Examples would include pavement structures, bridge components, and sign structures. This provision will not be used as a mechanism to force the Contractor to return to the project to make repairs or perform additional work that the Department would normally compensate the Contractor for. In addition, routine maintenance activities (i.e. mowing grass, debris removal, ruts in earth shoulders,) are not parts of this guarantee. Appropriate provisions of the payment and/or performance bonds shall cover this guarantee for the project. To ensure uniform application statewide the Division Engineer will forward details regarding the circumstances surrounding any proposed guarantee repairs to the Chief Engineer for review and approval prior to the work being performed.

OUTSOURCING OUTSIDE THE USA:

(9-21-04) (Rev. 5-16-06)

SP1 G150

All work on consultant contracts, services contracts, and construction contracts shall be performed in the United States of America. No work shall be outsourced outside of the United States of America.

Outsourcing for the purpose of this provision is defined as the practice of subcontracting labor, work, services, staffing, or personnel to entities located outside of the United States.

The North Carolina Secretary of Transportation shall approve exceptions to this provision in writing.

EQUIPMENT:

The Contractor shall furnish all equipment in good operating condition, and shall be operated by properly trained and qualified personnel. The Contractor shall be responsible for all costs or charges incurred in the operation and maintenance of the equipment during the performance of this contract. Upon request, the contractor shall provide any and all state and federal certifications for equipment safety.

Payment for equipment and labor required to perform bid items is included in the bid item price provided by the contractor. Mobilization of labor and equipment shall be included in the bid item price provided by the contractor.

PAYMENT:

The **INVOICE**, along with any **SUBCONTRACTOR PAYMENT INFORMATION**, shall be completed for each month work is performed and shall be submitted to the Department. Upon verification, the Engineer will submit the invoice for payment.

Invoices shall be submitted to:

**N.C. Department of Transportation
Division 6 – Bridge Maint.
ATTENTION: Darren Pittman
P.O. Box 1150
Fayetteville, N.C. 28302**

PRECONSTRUCTION CONFERENCE

In accordance with Section 108-3 of the Standard Specifications, a preconstruction conference will be required prior to beginning work.

SUPERVISION BY CONTRACTOR:

At all times during the life of the project the Contractor shall provide one permanent employee who shall have the authority and capability for overall responsibility of the project and who shall be personally available at the work site within 24 hours notice. Such employee shall be fully authorized to conduct all business with the Subcontractors, to negotiate and execute all supplemental agreements, and to execute the orders or directions of the Engineer.

At all times that work is actually being performed, the Contractor shall have present on the project one competent individual who is authorized to act in a supervisory capacity over all work on the project, including work subcontracted. The individual who has been so authorized shall be experienced in the type of work being performed and shall be fully capable of managing, directing, and coordinating the work; of reading and thoroughly understanding the contract; and receiving and carrying out directions from the Engineer or his authorized representatives. He shall be an employee of the Contractor unless otherwise approved by the Engineer.

The Contractor may, at his option, designate one employee to meet the requirements of both positions. However, whenever the designated employee is absent from the work site, an authorized individual qualified to act in a supervisory capacity on the project shall be present.

STANDARD SPECIAL PROVISION**AVAILABILITY OF FUNDS – TERMINATION OF CONTRACTS**

(5-20-08)

Z-2

General Statute 143C-6-11. (h) Highway Appropriation is hereby incorporated verbatim in this contract as follows:

(h) Amounts Encumbered. – Transportation project appropriations may be encumbered in the amount of allotments made to the Department of Transportation by the Director for the estimated payments for transportation project contract work to be performed in the appropriation fiscal year. The allotments shall be multiyear allotments and shall be based on estimated revenues and shall be subject to the maximum contract authority contained in *General Statute 143C-6-11(c)*. Payment for transportation project work performed pursuant to contract in any fiscal year other than the current fiscal year is subject to appropriations by the General Assembly. Transportation project contracts shall contain a schedule of estimated completion progress, and any acceleration of this progress shall be subject to the approval of the Department of Transportation provided funds are available. The State reserves the right to terminate or suspend any transportation project contract, and any transportation project contract shall be so terminated or suspended if funds will not be available for payment of the work to be performed during that fiscal year pursuant to the contract. In the event of termination of any contract, the contractor shall be given a written notice of termination at least 60 days before completion of scheduled work for which funds are available. In the event of termination, the contractor shall be paid for the work already performed in accordance with the contract specifications.

Payment will be made on any contract terminated pursuant to the special provision in accordance with Subarticle 108-13(D) of the *2018 Standard Specifications*.

STANDARD SPECIAL PROVISION**ERRATA**

(10-16-18) (Rev.2-16-21)

Z-4

Revise the *2018 Standard Specifications* as follows:

Division 6

Page 6-7, Article 609-1 DESCRIPTION, line 29, replace article number “609-10” with “609-9”.

Division 7

Page 7-27, Article 725-1 MEASUREMENT AND PAYMENT, line 4, replace article number “725-1” with “724-4”.

Page 7-28, Article 725-1 MEASUREMENT AND PAYMENT, line 10, replace article number “725-1” with “725-3”.

Division 10

Page 10-78, Article 1056-4 GEOTEXTILES, TABLE 1056-1, Permittivity, Type 2, replace “Table 6^D” with “Table 7^D” and **Permittivity, Type 3^B,** replace “Table 7^D” with “Table 8^D”.

Page 10-121, Article 1076-7, REPAIR OF GALVANIZING, line 8, replace article number “1080-9” with “1080-7”.

Page 10-162, Article 1080-50 PAINT FOR VERTICAL MARKERS, line 1, replace article number “1080-50” with “1080-10”.

Page 10-162, Article 1080-61 EPOXY RESIN FOR REINFORCING STEEL, line 5, replace article number “1080-61” with “1080-11”.

Page 10-162, Article 1080-72 ABRASIVE MATERIALS FOR BLAST CLEANING STEEL, line 22, replace article number “1080-72” with “1080-12”.

Page 10-163, Article 1080-83 FIELD PERFORMANCE AND SERVICES, line 25, replace article number “1080-83” with “1080-13”.

Division 17

Page 17-15, Article 1715-4 MEASUREMENT AND PAYMENT, lines 42-44, replace the second sentence with the following:

An example is an installation of a single 1.25 inch HDPE conduit would be paid as:

Directional Drill (1)(1.25”) Linear Foot

STANDARD SPECIAL PROVISION**PLANT AND PEST QUARANTINES****(Imported Fire Ant, Gypsy Moth, Witchweed, Emerald Ash Borer, Guava Root Knot Nematode, And Other Noxious Weeds)**

(3-18-03) (Rev. 5-21-19)

Z-04a

Within Quarantined Area

This project may be within a county regulated for plant and/or pests. If the project or any part of the Contractor's operations is located within a quarantined area, thoroughly clean all equipment prior to moving out of the quarantined area. Comply with federal/state regulations by obtaining a certificate or limited permit for any regulated article moving from the quarantined area.

Originating in a Quarantined County

Obtain a certificate or limited permit issued by the N.C. Department of Agriculture/United States Department of Agriculture. Have the certificate or limited permit accompany the article when it arrives at the project site.

Contact

Contact the N.C. Department of Agriculture/United States Department of Agriculture at 1-800-206-9333, 919-707-3730, or <https://www.ncagr.gov/plantindustry/Plant/quaran/table2.htm> to determine those specific project sites located in the quarantined area or for any regulated article used on this project originating in a quarantined county.

Regulated Articles Include

1. Soil, sand, gravel, compost, peat, humus, muck, and decomposed manure, separately or with other articles. This includes movement of articles listed above that may be associated with cut/waste, ditch pulling, and shoulder cutting.
2. Plants with roots including grass sod.
3. Plant crowns and roots.
4. Bulbs, corms, rhizomes, and tubers of ornamental plants.
5. Hay, straw, fodder, and plant litter of any kind.
6. Clearing and grubbing debris.
7. Used agricultural cultivating and harvesting equipment.
8. Used earth-moving equipment.
9. Any other products, articles, or means of conveyance, of any character, if determined by an inspector to present a hazard of spreading imported fire ant, gypsy moth, witchweed, emerald ash borer, guava root knot nematode, or other noxious weeds.

STANDARD SPECIAL PROVISION**MINIMUM WAGES**

(7-21-09)

Z-5

FEDERAL: The Fair Labor Standards Act provides that with certain exceptions every employer shall pay wages at the rate of not less than SEVEN DOLLARS AND TWENTY FIVE CENTS (\$7.25) per hour.

STATE: The North Carolina Minimum Wage Act provides that every employer shall pay to each of his employees, wages at a rate of not less than SEVEN DOLLARS AND TWENTY FIVE CENTS (\$7.25) per hour.

The minimum wage paid to all skilled labor employed on this contract shall be SEVEN DOLLARS AND TWENTY FIVE CENTS (\$7.25) per hour.

The minimum wage paid to all intermediate labor employed on this contract shall be SEVEN DOLLARS AND TWENTY FIVE CENTS (\$7.25) per hour.

The minimum wage paid to all unskilled labor on this contract shall be SEVEN DOLLARS AND TWENTY FIVE CENTS (\$7.25) per hour.

This determination of the intent of the application of this act to the contract on this project is the responsibility of the Contractor.

The Contractor shall have no claim against the Department of Transportation for any changes in the minimum wage laws, Federal or State. It is the responsibility of the Contractor to keep fully informed of all Federal and State Laws affecting his contract.

STANDARD SPECIAL PROVISION**TITLE VI AND NONDISCRIMINATION:**

(6-28-77)(Rev 6/19/2018)

Z-6

Revise the *2018 Standard Specifications* as follows:

Replace Article 103-4(B) with the following:

The North Carolina Department of Transportation is committed to carrying out the U.S. Department of Transportation's policy of ensuring nondiscrimination in the award and administration of contracts.

The provisions of this section related to United States Department of Transportation (US DOT) Order 1050.2A, Title 49 Code of Federal Regulations (CFR) part 21, 23 United States Code (U.S.C.) 140 and 23 CFR part 200 (or 49 CFR 303, 49 U.S.C. 5332 or 49 U.S.C. 47123) are applicable to all North Carolina Department of Transportation (NCDOT) contracts and to all related subcontracts, material supply, engineering, architectural and other service contracts, regardless of dollar amount. Any Federal provision that is specifically required not specifically set forth is hereby incorporated by reference.

(1) Title VI Assurances (USDOT Order 1050.2A, Appendix A)

During the performance of this contract, the contractor, for itself, its assignees, and successors in interest (hereinafter referred to as the "contractor") agrees as follows:

(a) Compliance with Regulations

The contractor (hereinafter includes consultants) shall comply with the Acts and the Regulations relative to Nondiscrimination in Federally-assisted programs of the U.S. Department of Transportation, Federal Highway Administration (FHWA), as they may be amended from time to time, which are herein incorporated by reference and made a part of this contract.

(b) Nondiscrimination

The contractor, with regard to the work performed by it during the contract, shall not discriminate on the grounds of race, color, or national origin in the selection and retention of subcontractors, including procurements of materials and leases of equipment. The contractor shall not participate directly or indirectly in the discrimination prohibited by the Acts and the Regulations, including employment practices when the contract covers any activity, project, or program set forth in Appendix B of 49 CFR Part 21.

(c) Solicitations for Subcontractors, Including Procurements of Materials and Equipment

In all solicitations, either by competitive bidding, or negotiation made by the contractor for work to be performed under a subcontract, including procurements of materials, or leases of equipment, each potential subcontractor or supplier shall be notified by the contractor of the contractor's obligations under this contract and the Acts and the Regulations relative to Nondiscrimination on the grounds of race, color, or national origin.

(d) Information and Reports

The contractor shall provide all information and reports required by the Acts, the Regulations, and directives issued pursuant thereto and shall permit access to its books, records, accounts, other sources of information, and its facilities as may be determined by the Recipient or the FHWA to be pertinent to ascertain compliance with such Acts, Regulations, and instructions. Where any information required of a contractor is in the exclusive possession of another who

fails or refuses to furnish the information, the contractor shall so certify to the Recipient or the FHWA, as appropriate, and shall set forth what efforts it has made to obtain the information.

(e) Sanctions for Noncompliance:

In the event of a contractor's noncompliance with the Non-discrimination provisions of this contract, the Recipient will impose such contract sanctions as it and/or the FHWA may determine to be appropriate, including, but not limited to:

- (i) Withholding payments to the contractor under the contract until the contractor complies; and/or
- (ii) Cancelling, terminating, or suspending a contract, in whole or in part.

(f) Incorporation of Provisions

The contractor shall include the provisions of paragraphs one through six in every subcontract, including procurements of materials and leases of equipment, unless exempt by the Acts, the Regulations and directives issued pursuant thereto. The contractor shall take action with respect to any subcontract or procurement as the Recipient or the FHWA may direct as a means of enforcing such provisions including sanctions for noncompliance. Provided, that if the contractor becomes involved in, or is threatened with litigation by a subcontractor, or supplier because of such direction, the contractor may request the Recipient to enter into any litigation to protect the interests of the Recipient. In addition, the contractor may request the United States to enter into the litigation to protect the interests of the United States.

(2) Title VI Nondiscrimination Program (23 CFR 200.5(p))

The North Carolina Department of Transportation (NCDOT) has assured the USDOT that, as a condition to receiving federal financial assistance, NCDOT will comply with Title VI of the Civil Rights Act of 1964 and all requirements imposed by Title 49 CFR part 21 and related nondiscrimination authorities to ensure that no person shall, on the ground of race, color, national origin, limited English proficiency, sex, age, or disability (including religion/creed or income-level, where applicable), be excluded from participation in, be denied the benefits of, or be subjected to discrimination under any programs, activities, or services conducted or funded by NCDOT. Contractors and other organizations under contract or agreement with NCDOT must also comply with Title VI and related authorities, therefore:

(a) During the performance of this contract or agreement, contractors (e.g., subcontractors, consultants, vendors, prime contractors) are responsible for complying with NCDOT's Title VI Program. Contractors are not required to prepare or submit Title VI Programs. To comply with this section, the prime contractor shall:

1. Post NCDOT's Notice of Nondiscrimination and the Contractor's own Equal Employment Opportunity (EEO) Policy in conspicuous locations accessible to all employees, applicants and subcontractors on the jobsite.
2. Physically incorporate the required Title VI clauses into all subcontracts on federally-assisted and state-funded NCDOT projects, and ensure inclusion by subcontractors into all lower-tier subcontracts.
3. Required Solicitation Language. The Contractor shall include the following notification in all solicitations for bids and requests for work or material, regardless of funding source:

"The North Carolina Department of Transportation, in accordance with the provisions of Title VI of the Civil Rights Act of 1964 (78 Stat. 252, 42 U.S.C. §§ 2000d to 2000d-4) and the Regulations, hereby notifies all bidders that it will affirmatively ensure that any contract

entered into pursuant to this advertisement, disadvantaged business enterprises will be afforded full and fair opportunity to submit bids in response to this invitation and will not be discriminated against on the grounds of race, color, or national origin in consideration for an award. In accordance with other related nondiscrimination authorities, bidders and contractors will also not be discriminated against on the grounds of sex, age, disability, low-income level, creed/religion, or limited English proficiency in consideration for an award.”

4. Physically incorporate the FHWA-1273, in its entirety, into all subcontracts and subsequent lower tier subcontracts on Federal-aid highway construction contracts only.
 5. Provide language assistance services (i.e., written translation and oral interpretation), free of charge, to LEP employees and applicants. Contact NCDOT OCR for further assistance, if needed.
 6. For assistance with these Title VI requirements, contact the NCDOT Title VI Nondiscrimination Program at 1-800-522-0453.
- (b) Subrecipients (e.g. cities, counties, LGAs, planning organizations) may be required to prepare and submit a Title VI Plan to NCDOT, including Title VI Assurances and/or agreements. Subrecipients must also ensure compliance by their contractors and subrecipients with Title VI. (23 CFR 200.9(b)(7))
- (c) If reviewed or investigated by NCDOT, the contractor or subrecipient agrees to take affirmative action to correct any deficiencies found within a reasonable time period, not to exceed 90 calendar days, unless additional time is granted by NCDOT. (23 CFR 200.9(b)(15))
- (d) The Contractor is responsible for notifying subcontractors of NCDOT’s External Discrimination Complaints Process.
1. Applicability

Title VI and related laws protect participants and beneficiaries (e.g., members of the public and contractors) from discrimination by NCDOT employees, subrecipients and contractors, regardless of funding source.
 2. Eligibility

Any person—or class of persons—who believes he/she has been subjected to discrimination based on race, color, national origin, Limited English Proficiency (LEP), sex, age, or disability (and religion in the context of employment, aviation, or transit) may file a written complaint. The law also prohibits intimidation or retaliation of any sort.
 3. Time Limits and Filing Options

Complaints may be filed by the affected individual(s) or a representative and must be filed no later than 180 calendar days after the following:

 - (i) The date of the alleged act of discrimination; or
 - (ii) The date when the person(s) became aware of the alleged discrimination; or
 - (iii) Where there has been a continuing course of conduct, the date on which that conduct was discontinued or the latest instance of the conduct.

Title VI and related discrimination complaints may be submitted to the following entities:

 - North Carolina Department of Transportation, Office of Civil Rights, Title VI Program, 1511 Mail Service Center, Raleigh, NC 27699-1511; toll free 1-800-522-0453
 - Federal Highway Administration, North Carolina Division Office, 310 New Bern Avenue, Suite 410, Raleigh, NC 27601, 919-747-7010

- US Department of Transportation, Departmental Office of Civil Rights, External Civil Rights Programs Division, 1200 New Jersey Avenue, SE, Washington, DC 20590; 202-366-4070

4. Format for Complaints

Complaints must be in writing and signed by the complainant(s) or a representative, and include the complainant’s name, address, and telephone number. Complaints received by fax or e-mail will be acknowledged and processed. Allegations received by telephone will be reduced to writing and provided to the complainant for confirmation or revision before processing. Complaints will be accepted in other languages, including Braille.

5. Discrimination Complaint Form

Contact NCDOT Civil Rights to receive a full copy of the Discrimination Complaint Form and procedures.

6. Complaint Basis

Allegations must be based on issues involving race, color, national origin (LEP), sex, age, disability, or religion (in the context of employment, aviation or transit). “Basis” refers to the complainant’s membership in a protected group category.

TABLE 103-1 COMPLAINT BASIS			
Protected Categories	Definition	Examples	Applicable Nondiscrimination Authorities
Race and Ethnicity	An individual belonging to one of the accepted racial groups; or the perception, based usually on physical characteristics that a person is a member of a racial group	Black/African American, Hispanic/Latino, Asian, American Indian/Alaska Native, Native Hawaiian/Pacific Islander, White	Title VI of the Civil Rights Act of 1964; 49 CFR Part 21; 23 CFR 200; 49 U.S.C. 5332(b); 49 U.S.C. 47123. <i>(Executive Order 13166)</i>
Color	Color of skin, including shade of skin within a racial group	Black, White, brown, yellow, etc.	
National Origin (<i>Limited English Proficiency</i>)	Place of birth. Citizenship is not a factor. (<i>Discrimination based on language or a person’s accent is also covered</i>)	Mexican, Cuban, Japanese, Vietnamese, Chinese	
Sex	Gender. The sex of an individual. <i>Note: Sex under this program does not include sexual orientation.</i>	Women and Men	1973 Federal-Aid Highway Act; 49 U.S.C. 5332(b); 49 U.S.C. 47123.
Age	Persons of any age	21-year-old person	Age Discrimination Act of 1975 49 U.S.C. 5332(b); 49 U.S.C. 47123.
Disability	Physical or mental impairment, permanent or temporary, or perceived.	Blind, alcoholic, para-amputee, epileptic, diabetic, arthritic	Section 504 of the Rehabilitation Act of 1973; Americans with Disabilities Act of 1990

<p>Religion (in the context of employment) <i>(Religion/ Creed in all aspects of any aviation or transit-related construction)</i></p>	<p>An individual belonging to a religious group; or the perception, based on distinguishable characteristics that a person is a member of a religious group. In practice, actions taken as a result of the moral and ethical beliefs as to what is right and wrong, which are sincerely held with the strength of traditional religious views. Note: Does not have to be associated with a recognized religious group or church; if an individual sincerely holds to the belief, it is a protected religious practice.</p>	<p>Muslim, Christian, Sikh, Hindu, etc.</p>	<p>Title VII of the Civil Rights Act of 1964; 23 CFR 230; FHWA-1273 Required Contract Provisions. (49 U.S.C. 5332(b); 49 U.S.C. 47123)</p>
--	---	---	--

(3) Pertinent Nondiscrimination Authorities

During the performance of this contract, the contractor, for itself, its assignees, and successors in interest agrees to comply with the following non-discrimination statutes and authorities, including, but not limited to:

- Title VI of the Civil Rights Act of 1964 (42 U.S.C. § 2000d et seq., 78 stat. 252), (prohibits discrimination on the basis of race, color, national origin); and 49 CFR Part 21.
- The Uniform Relocation Assistance and Real Property Acquisition Policies Act of 1970, (42 U.S.C. § 4601), (prohibits unfair treatment of persons displaced or whose property has been acquired because of Federal or Federal-aid programs and projects);
- Federal-Aid Highway Act of 1973, (23 U.S.C. § 324 et seq.), (prohibits discrimination on the basis of sex);
- Section 504 of the Rehabilitation Act of 1973, (29 U.S.C. § 794 et seq.), as amended, (prohibits discrimination on the basis of disability) and 49 CFR Part 27;
- The Age Discrimination Act of 1975, as amended, (42 U.S.C. § 6101 et seq.), (prohibits discrimination on the basis of age);
- Airport and Airway Improvement Act of 1982, (49 USC § 471, Section 47123), as amended, (prohibits discrimination based on race, creed, color, national origin, or sex);
- (g) The Civil Rights Restoration Act of 1987, (PL 100-209), (Broadened the scope, coverage and applicability of Title VI of the Civil Rights Act of 1964, The Age Discrimination Act of 1975 and Section 504 of the Rehabilitation Act of 1973, by expanding the definition of the terms "programs or activities" to include all of the programs or activities of the Federal-aid recipients, sub-recipients and contractors, whether such programs or activities are Federally funded or not);
- (h) Titles II and III of the Americans with Disabilities Act, which prohibit discrimination on the basis of disability in the operation of public entities, public and private transportation systems, places of public accommodation, and certain testing entities (42 U.S.C. §§ 12131-12189) as implemented by Department of Transportation regulations at 49 C.F.R. parts 37 and 38;
- (i) The Federal Aviation Administration's Nondiscrimination statute (49 U.S.C. § 47123) (prohibits discrimination on the basis of race, color, national origin, and sex);
- (j) Executive Order 12898, Federal Actions to Address Environmental Justice in Minority Populations and Low-Income Populations, which ensures Nondiscrimination against minority populations by discouraging programs, policies, and activities with disproportionately high and adverse human health or environmental effects on minority and low-income populations;

- (k) Executive Order 13166, Improving Access to Services for Persons with Limited English Proficiency, and resulting agency guidance, national origin discrimination includes discrimination because of Limited English proficiency (LEP). To ensure compliance with Title VI, you must take reasonable steps to ensure that LEP persons have meaningful access to your programs (70 Fed. Reg. at 74087 to 74100);
- (l) Title IX of the Education Amendments of 1972, as amended, which prohibits you from discriminating because of sex in education programs or activities (20 U.S.C. 1681 et seq).
- (m) Title VII of the Civil Rights Act of 1964 (42 U.S.C. § 2000e et seq., Pub. L. 88-352), (prohibits employment discrimination on the basis of race, color, religion, sex, or national origin).

(4) Additional Title VI Assurances

***The following Title VI Assurances (Appendices B, C and D) shall apply, as applicable*

(a) Clauses for Deeds Transferring United States Property (1050.2A, Appendix B)

The following clauses will be included in deeds effecting or recording the transfer of real property, structures, or improvements thereon, or granting interest therein from the United States pursuant to the provisions of Assurance 4.

NOW, THEREFORE, the U.S. Department of Transportation as authorized by law and upon the condition that the North Carolina Department of Transportation (NCDOT) will accept title to the lands and maintain the project constructed thereon in accordance with the North Carolina General Assembly, the Regulations for the Administration of the Federal-Aid Highway Program, and the policies and procedures prescribed by the Federal Highway Administration of the U.S. Department of Transportation in accordance and in compliance with all requirements imposed by Title 49, Code of Federal Regulations, U.S. Department of Transportation, Subtitle A, Office of the Secretary, Part 21, Nondiscrimination in Federally-assisted programs of the U.S. Department of Transportation pertaining to and effectuating the provisions of Title VI of the Civil Rights Act of 1964 (78 Stat. 252; 42 U.S.C. § 2000d to 2000d-4), does hereby remise, release, quitclaim and convey unto the NCDOT all the right, title and interest of the U.S. Department of Transportation in and to said lands described in Exhibit A attached hereto and made a part hereof.

(HABENDUM CLAUSE)

TO HAVE AND TO HOLD said lands and interests therein unto the North Carolina Department of Transportation (NCDOT) and its successors forever, subject, however, to the covenants, conditions, restrictions and reservations herein contained as follows, which will remain in effect for the period during which the real property or structures are used for a purpose for which Federal financial assistance is extended or for another purpose involving the provision of similar services or benefits and will be binding on the NCDOT, its successors and assigns.

The NCDOT, in consideration of the conveyance of said lands and interests in lands, does hereby covenant and agree as a covenant running with the land for itself, its successors and assigns, that (1) no person will on the grounds of race, color, or national origin, be excluded from participation in, be denied the benefits of, or be otherwise subjected to discrimination with regard to any facility located wholly or in part on, over, or under such lands hereby conveyed [,] [and]* (2) that the NCDOT will use the lands and interests in lands and interests in lands so conveyed, in compliance with all requirements imposed by or pursuant to Title 49, Code of Federal Regulations, U.S. Department of Transportation, Subtitle A, Office of the Secretary, Part 21, Non-discrimination in Federally-assisted programs of the U.S. Department of Transportation, Effectuation of Title VI of the Civil Rights Act of 1964, and as said Regulations and Acts may be amended [, and (3) that in the event of breach of any of the above-mentioned nondiscrimination conditions, the Department will have a right to enter or re-enter said lands and facilities on said land, and that above described land and facilities will thereon revert to and vest in and become the absolute property of the U.S. Department of Transportation and its assigns as such interest existed prior to this instruction].*

(*Reverter clause and related language to be used only when it is determined that such a clause is necessary in order to make clear the purpose of Title VI.)

(b) Clauses for Transfer of Real Property Acquired or Improved Under the Activity, Facility, or Program (1050.2A, Appendix C)

The following clauses will be included in deeds, licenses, leases, permits, or similar instruments entered into by the North Carolina Department of Transportation (NCDOT) pursuant to the provisions of Assurance 7(a):

1. The (grantee, lessee, permittee, etc. as appropriate) for himself/herself, his/her heirs, personal representatives, successors in interest, and assigns, as a part of the consideration hereof, does hereby covenant and agree [in the case of deeds and leases add "as a covenant running with the land"] that:
 - (i.) In the event facilities are constructed, maintained, or otherwise operated on the property described in this (deed, license, lease, permit, etc.) for a purpose for which a U.S. Department of Transportation activity, facility, or program is extended or for another purpose involving the provision of similar services or benefits, the (grantee, licensee, lessee, permittee, etc.) will maintain and operate such facilities and services in compliance with all requirements imposed by the Acts and Regulations (as may be amended) such that no person on the grounds of race, color, or national origin, will be excluded from participation in, denied the benefits of, or be otherwise subjected to discrimination in the use of said facilities.
2. With respect to licenses, leases, permits, etc., in the event of breach of any of the above Nondiscrimination covenants, the NCDOT will have the right to terminate the (lease, license, permit, etc.) and to enter, re-enter, and repossess said lands and facilities thereon, and hold the same as if the (lease, license, permit, etc.) had never been made or issued. *
3. With respect to a deed, in the event of breach of any of the above Nondiscrimination covenants, the NCDOT will have the right to enter or re-enter the lands and facilities thereon, and the above described lands and facilities will there upon revert to and vest in and become the absolute property of the NCDOT and its assigns. *

(*Reverter clause and related language to be used only when it is determined that such a clause is necessary to make clear the purpose of Title VI.)

(c) Clauses for Construction/Use/Access to Real Property Acquired Under the Activity, Facility or Program (1050.2A, Appendix D)

The following clauses will be included in deeds, licenses, permits, or similar instruments/agreements entered into by the North Carolina Department of Transportation (NCDOT) pursuant to the provisions of Assurance 7(b):

1. The (grantee, licensee, permittee, etc., as appropriate) for himself/herself, his/her heirs, personal representatives, successors in interest, and assigns, as a part of the consideration hereof, does hereby covenant and agree (in the case of deeds and leases add, "as a covenant running with the land") that (1) no person on the ground of race, color, or national origin, will be excluded from participation in, denied the benefits of, or be otherwise subjected to discrimination in the use of said facilities, (2) that in the construction of any improvements on, over, or under such land, and the furnishing of services thereon, no person on the ground of race, color, or national origin, will be excluded from participation in, denied the benefits of, or otherwise be subjected to discrimination, (3) that the (grantee, licensee, lessee, permittee, etc.) will use the premises in compliance with all other requirements imposed by or pursuant to the Acts and Regulations, as amended, set forth in this Assurance.
2. With respect to (licenses, leases, permits, etc.), in the event of breach of any of the above Non-discrimination covenants, the NCDOT will have the right to terminate the (license, permit, etc., as appropriate) and to enter or re-enter and repossess said land and the facilities thereon, and hold the same as if said (license, permit, etc., as appropriate) had never been made or issued. *
3. With respect to deeds, in the event of breach of any of the above Nondiscrimination covenants, the NCDOT will there upon revert to and vest in and become the absolute property of the NCDOT and its assigns. *

(*Reverter clause and related language to be used only when it is determined that such a clause is necessary to make clear the purpose of Title VI.)

STANDARD SPECIAL PROVISION**ON-THE-JOB TRAINING**

(10-16-07) (Rev. 4-21-15)

Z-10

Description

The North Carolina Department of Transportation will administer a custom version of the Federal On-the-Job Training (OJT) Program, commonly referred to as the Alternate OJT Program. All contractors (existing and newcomers) will be automatically placed in the Alternate Program. Standard OJT requirements typically associated with individual projects will no longer be applied at the project level. Instead, these requirements will be applicable on an annual basis for each contractor administered by the OJT Program Manager.

On the Job Training shall meet the requirements of 23 CFR 230.107 (b), 23 USC – Section 140, this provision and the On-the-Job Training Program Manual.

The Alternate OJT Program will allow a contractor to train employees on Federal, State and privately funded projects located in North Carolina. However, priority shall be given to training employees on NCDOT Federal-Aid funded projects.

Minorities and Women

Developing, training and upgrading of minorities and women toward journeyman level status is a primary objective of this special training provision. Accordingly, the Contractor shall make every effort to enroll minority and women as trainees to the extent that such persons are available within a reasonable area of recruitment. This training commitment is not intended, and shall not be used, to discriminate against any applicant for training, whether a member of a minority group or not.

Assigning Training Goals

The Department, through the OJT Program Manager, will assign training goals for a calendar year based on the contractors' past three years' activity and the contractors' anticipated upcoming year's activity with the Department. At the beginning of each year, all contractors eligible will be contacted by the Department to determine the number of trainees that will be assigned for the upcoming calendar year. At that time the Contractor shall enter into an agreement with the Department to provide a self-imposed on-the-job training program for the calendar year. This agreement will include a specific number of annual training goals agreed to by both parties. The number of training assignments may range from 1 to 15 per contractor per calendar year. The Contractor shall sign an agreement to fulfill their annual goal for the year.

Training Classifications

The Contractor shall provide on-the-job training aimed at developing full journeyman level workers in the construction craft/operator positions. Preference shall be given to providing training in the following skilled work classifications:

Equipment Operators	Office Engineers
Truck Drivers	Estimators
Carpenters	Iron / Reinforcing Steel Workers
Concrete Finishers	Mechanics
Pipe Layers	Welders

The Department has established common training classifications and their respective training requirements that may be used by the contractors. However, the classifications established are not all-inclusive. Where the training is oriented toward construction applications, training will be allowed in lower-level management positions such as office engineers and estimators. Contractors shall submit new classifications for specific job functions that their employees are performing. The Department will review and recommend for acceptance to FHWA the new classifications proposed by contractors, if applicable. New classifications shall meet the following requirements:

Proposed training classifications are reasonable and realistic based on the job skill classification needs, and

The number of training hours specified in the training classification is consistent with common practices and provides enough time for the trainee to obtain journeyman level status.

The Contractor may allow trainees to be trained by a subcontractor provided that the Contractor retains primary responsibility for meeting the training and this provision is made applicable to the subcontract. However, only the Contractor will receive credit towards the annual goal for the trainee.

Where feasible, 25 percent of apprentices or trainees in each occupation shall be in their first year of apprenticeship or training. The number of trainees shall be distributed among the work classifications on the basis of the contractor's needs and the availability of journeymen in the various classifications within a reasonable area of recruitment.

No employee shall be employed as a trainee in any classification in which they have successfully completed a training course leading to journeyman level status or in which they have been employed as a journeyman.

Records and Reports

The Contractor shall maintain enrollment, monthly and completion reports documenting company compliance under these contract documents. These documents and any other information as requested shall be submitted to the OJT Program Manager.

Upon completion and graduation of the program, the Contractor shall provide each trainee with a certification Certificate showing the type and length of training satisfactorily completed.

Trainee Interviews

All trainees enrolled in the program will receive an initial and Trainee/Post graduate interview conducted by the OJT program staff.

Trainee Wages

Contractors shall compensate trainees on a graduating pay scale based upon a percentage of the prevailing minimum journeyman wages (Davis-Bacon Act). Minimum pay shall be as follows:

60 percent	of the journeyman wage for the first half of the training period
75 percent	of the journeyman wage for the third quarter of the training period
90 percent	of the journeyman wage for the last quarter of the training period

In no instance shall a trainee be paid less than the local minimum wage. The Contractor shall adhere to the minimum hourly wage rate that will satisfy both the NC Department of Labor (NCDOL) and the Department.

Achieving or Failing to Meet Training Goals

The Contractor will be credited for each trainee employed by him on the contract work who is currently enrolled or becomes enrolled in an approved program and who receives training for at least 50 percent of the specific program requirement. Trainees will be allowed to be transferred between projects if required by the Contractor's scheduled workload to meet training goals.

If a contractor fails to attain their training assignments for the calendar year, they may be taken off the NCDOT's Bidders List.

Measurement and Payment

No compensation will be made for providing required training in accordance with these contract documents.

PROJECT SPECIAL PROVISIONS**ROADWAY****NOTES TO CONTRACTOR:**

The Contractors attention is directed to the following:

1. This is an as needed, "On Call" type contract, and no amount of work is guaranteed.
2. The Contractor shall provide an anticipated completion schedule within 30 days of receiving notice of an assigned project.
3. All lane closures shall be approved by Darren Pittman - Division Bridge Maintenance Engineer.
4. All products must be NCDOT certified and are subject to testing by NCDOT at any time.
5. If the Engineer or Project Inspector determines that any work completed by the Contractor is not satisfactory, the work shall be corrected per the direction of the Engineer at no cost to the Department.

NOTIFICATION OF OPERATIONS:

The Contractor shall notify the Engineer two (2) weeks in advance of beginning work on this project.

The Contractor shall give the Engineer sufficient notice of all operations for any sampling, inspection or acceptance testing required. All routes may not be available by the above listed date. The contractor will notify the Bridge Maintenance Office, or the Inspector at (910) 364-0670, daily of his/her intended schedule of work. This will allow the Bridge Maintenance Unit to schedule inspections accordingly.

INTERPRETATION OF QUANTITIES IN PROPOSAL FORM:

The quantities appearing in the proposal form are approximate only and are to be used for the comparison of bids. Payment to the Contractor will be made only for the actual quantities of the various items that are completed and accepted in accordance with the terms of the contract.

PROSECUTION AND PROGRESS:

The Contractor shall pursue the work diligently with workmen in sufficient numbers, abilities, and supervision, and with equipment, materials, and methods of construction as may be required to complete the work described in the contract by the completion date and in accordance with Section 108 of the Standard Specifications.

The Contractor shall prepare and submit to the Engineer a proposed schedule of operations prior to beginning work on this project. The schedule should indicate the proposed chronological sequence of operations and may be revised within the limits of the contract with the approval of the Engineer.

No work may be performed on legal State holidays. Work shall only be performed when weather and visibility conditions allow safe operations. The Contractor's vehicles and equipment shall not be parked

within the State Highway System right of way overnight or at other times when work has been suspended unless approved by the Engineer. The Engineer may designate specific locations for parking equipment.

The Contractor shall temporarily remove his equipment from the travel way for emergency vehicles and school buses as directed by the Engineer.

DRIVEWAYS AND PRIVATE PROPERTY:

The Contractor shall maintain access to driveways for all residents and property owners throughout the duration of the project.

The Contractor shall not perform work for private citizens or agencies in conjunction with this project or within the project limits of this contract.

PRESERVATION OF PROPERTY:

Permanent traffic signs and mailboxes that interfere with the road construction operations are to be removed during the course of a day's work, and be reinstalled at the conclusion of each work day. The Contractor shall mark the proper location of the signs and mailboxes by placing an offset stake behind the ditch line to ensure proper replacement.

Any damage to properties, such as, but not limited to, mailboxes, fences, gates, vehicles, driveways, etc. shall immediately be restored to the previously existing condition by the contractor. No payment will be made to the Contractor for such restorative work.

DAMAGE TO EXISTING PAVEMENT, BASE, SUBGRADE AND PROPOSED PAVEMENT:

In addition to the requirements of the Standard Specifications concerning this subject, the Contractor is cautioned that he/she will be held responsible for all damages to the pavement, base, and subgrade caused by their operations, including but not limited to, rutting and shoving of the existing or proposed pavement and yielding or rutting of the existing base and subgrade.

The Contractor is cautioned to limit the weight of his/her equipment and the frequency of hauls so as to not damage the existing pavement, base, subgrade and the proposed pavement.

Any subgrade or base failures which the Contractor finds prior to the beginning of his operations or during the conditioning of the existing base are to be brought to the attention of the Engineer in writing. Repairs to those areas will be made by DOT forces. Once these deficient areas have been repaired, the requirements of this Special Provision will fully apply notification.

DAMAGE TO PLANTS:

The Contractor shall conduct his operations in such a manner as to prevent injury to trees, shrubs, grass or legume ground cover, or other types of vegetation that are to remain growing, and also to prevent damage to adjacent property.

The Contractor shall be responsible for the replacement of any plant destroyed or damaged by any operation performed by the Contractor or any subsequent subcontractor.

MOBILIZATION:

The Engineer shall notify the contractor of bridge sites requiring joint replacements.

This work consists of preparatory work and operations to mobilize personnel, materials, and equipment to the project sites.

Method of Measurement and Basis of Payment

Mobilization shall be paid for each site/bridge until all work on that structure is done. Only one mobilization will be paid per site/bridge.

Travelling between work sites within Division 6 will not be paid for as Mobilization.

There will be a maximum limit of 1 reimbursable mobilization per site.

Basis of payment will be the contract unit price bid by route type, per each.

<u>Pay Item</u>	<u>Pay Unit</u>
Mobilization (Primary)	Each
Mobilization (Secondary)	Each

SILICON EXPANSION JOINT REPLACEMENT:

Contractor shall remove the existing expansion joint, clean the area in accordance with the manufacturer's recommendations, and place the silicon expansion joint in accordance with the manufacturer's recommendations. The expansion joint shall be replaced with the materials stated in this contract.

All materials shall be delivered unopened in their original containers bearing the manufacturer's label, date of manufacture, batch number, trade name brand, and quantity. Sufficient material to perform the entire expansion joint shall be "on hand" prior to removing the existing expansion joint. Stored materials may be inspected prior to their use and shall meet the requirements of these provisions. Each shipment of repair material shall be accompanied by Material Safety Data Sheets (MSDS) and a certificate of compliance certifying that the materials conform to the requirements of these provisions.

The repair material shall be one of the following approved products or equivalent.

Joints (1) inch or less in width:

Sealant – Dow 888

Baysilon 960 (silicon based)

Joints greater than one (1) inch in width:

Sealant – SILICONE (silicon based)

The entire cost for the silicon expansion joint replacement including but not limited to labor, maintenance, equipment, tools, and incidentals will be included in the unit prices for Silicon Joint Replacement.

Payment will be under:

<u>Pay Item</u>	<u>Pay Unit</u>
Silicon Joint Replacement - 1" or less (Primary)	LF
Silicon Joint Replacement - Greater than 1" (Primary)	LF
Silicon Joint Replacement - 1" or less (Secondary)	LF
Silicon Joint Replacement - Greater than 1" (Secondary)	LF

FOAM JOINT REPLACEMENT:**Joint openings less than or equal to five (5) inches in width.**

Contractor shall remove the existing expansion joint, clean and prep the area in accordance with the manufacturer's recommendations, and place the foam expansion joint in accordance with the manufacturer's recommendations. Contractor shall have a manufacturer's representative present during the installation of the first foam expansion joint of the project. The expansion joint shall be replaced with the materials stated in this contract.

Joint preparation shall include saw cut to a maximum width of three (3) inches. Foam joint replacement with saw cut will require a track mounted saw. If joint exceeds three (3) inches in width, contractor shall install foam joint with elastomeric concrete according to specifications. No additional compensation will be granted for track mounted saw.

All materials shall be delivered unopened in their original containers bearing the manufacturer's label, date of manufacture, batch number, trade name brand, and quantity. Sufficient material to perform the entire expansion joint shall be "on hand" prior to removing the existing expansion joint. Stored materials may be inspected prior to their use and shall meet the requirements of these provisions. Each shipment of repair material shall be accompanied by Material Safety Data Sheets (MSDS) and a certificate of compliance certifying that the materials conform to the requirements of these provisions.

Foam Joint Seal Specifications**Seals**

Use preformed seals compatible with concrete and resistant to abrasion, oxidation, oils, gasoline, salt and other materials that are spilled on or applied to the surface. Use a resilient, UV stable, preformed, impermeable, flexible, expansion joint seal. The joint seal shall consist of low-density, closed cell, cross-linked polyethylene non-extrudable, foam. The joint seal shall contain no EVA (Ethylene Vinyl Acetate). Cell generation shall be achieved by being physically blown using nitrogen. No chemical blowing agents shall be used in the cell generation process.

Use seals manufactured with grooves $1/8" \pm$ wide by $1/8" \pm$ deep and spaced between $1/4"$ and $1/2"$ apart along the bond surface running the length of the joint. Use seals with a depth that meets the manufacturer's recommendation, but is not less than 70% of the uncompressed width. Provide a seal designed so that, when compressed, the center portion of the top does not extend upward above the original height of the seal by more than $1/4"$. Provide a seal that has a working range of 30% tension and 60% compression and meets the requirements given below.

TEST	TEST METHOD	REQUIREMENT
Tensile strength	ASTM D3575-08, Suffix T	110 – 130 psi
Compression Set	ASTM D1056 Suffix B, 2 hr recovery	10% - 16%
Water Absorption	ASTM D3575	< 0.03 lb/ft ² (< 0.001 kpa)
Elongation at Break	ASTM D3575	180% - 210%
Tear Strength	ASTM D624 (D3575-08, Suffix G)	14 – 20 pli
Density	ASTM D3575-08, Suffix W, Method A	1.8 – 2.2 lb/ft ³ (28.8 – 35.2 kg/m ³)
Toxicity	ISO-10993.5	Pass (not cytotoxic)

Have the top of the joint seal clearly shop marked. Inspect the joint seals upon receipt to ensure that the marks are clearly visible before installation.

Bonding Adhesive

Use a two component, 100% solid, modified epoxy adhesive supplied by the joint seal manufacturer that meets the requirements given below.

TEST	TEST METHOD	REQUIREMENT
Tensile strength	ASTM D638	3000 psi (min.)
Compressive strength	ASTM D695	7000 psi (min.)
Hardness	Shore D Scale	75-85 psi
Water Absorption	ASTM D570	0.25% by weight max.
Elongation to Break	ASTM D638	5% (max.)
Bond Strength	ASTM C882	2000 psi (min.)

Use an adhesive that is workable to 40°F. When installing in ambient air or surface temperatures below 40°F or for application on moist, difficult to dry concrete surfaces, use an adhesive specified by the manufacturer of the joint seal.

Sawing the Joint

The joint opening shall be initially formed to the width shown on the plans including the blockout for the elastomeric concrete.

The elastomeric concrete shall have sufficient time to cure such that no damage can occur to the elastomeric concrete prior to sawing to the final width and depth as specified in the plans.

When sawing the joint to receive the foam seal, always use a rigid guide to control the saw in the desired direction. To control the saw and to produce a straight line as indicated on the plans, anchor and positively connect a template or a track to the bridge deck. Do not saw the joint by visual means such as a chalk line.

Fill the holes used for holding the template or track to the deck with an approved, flowable non-shrink, non-metallic grout.

Saw cut to the desired width and depth in one or two passes of the saw by placing and spacing two metal blades on the saw shaft to the desired width for the joint opening.

The desired depth is the depth of the seal plus 1/4" above the top of the seal plus approximately 1" below the bottom of the seal. An irregular bottom of sawed joint is permitted as indicated on the plans. Grind exposed corners on saw cut edges to a 1/4" chamfer.

Saw cut a straight joint, centered over the formed opening and to the desired width specified in the plans. Prevent any chipping or damage to the sawed edges of the joint.

Remove any staining or deposited material resulting from sawing with a wet blade to the satisfaction of the Engineer.

Preparation of Sawed Joint for Seal installation

The elastomeric concrete shall cure a minimum of 24 hours prior to seal installation.

After sawing the joint, the Engineer will thoroughly inspect the sawed joint opening for spalls, popouts, cracks, etc. All necessary repairs will be made by the Contractor prior to blast cleaning and installing the seal.

Clean the joints by sandblasting with clean dry sand immediately before placing the bonding agent. Sandblast the joint opening to provide a firm, clean joint surface free of curing compound, loose material and any foreign matter. Sandblast the joint opening without causing pitting or uneven surfaces. The aggregate in the elastomeric concrete may be exposed after sandblasting.

After blasting, either brush the surface with clean brushes made of hair, bristle or fiber, blow the surface with compressed air, or vacuum the surface until all traces of blast products and abrasives are removed from the surface, pockets, and corners.

If nozzle blasting is used to clean the joint opening, use compressed air that does not contain detrimental amounts of water or oil.

Examine the blast cleaned surface and remove any traces of oil, grease or smudge deposited in the cleaning operations.

Bond the seal to the blast cleaned surface on the same day the surface is blast cleaned.

Seal Installation

Install the joint seal according to the manufacturer's procedures and recommendations and as recommended below. Do not install the joint seal if the ambient air or surface temperature is below 45°F. Have a manufacturer's certified trained factory representative present during the installation of the first seal of the project.

Before installing the joint seal, check the uninstalled seal length to insure the seal is the same length as the deck opening. When the joint seal requires splicing, use the heat welding method by placing the joint material ends against a teflon heating iron of 425-475°F for 7 - 10 seconds, then pressing the ends together tightly. Do not test the welding until the material has completely cooled.

Begin installation by protecting the top edges of the concrete deck adjacent to the vertical walls of the joint as a means to minimize clean up. After opening both cans of the bonding agent, stir each can using separate stirring rods for each component to prevent premature curing of the bonding agent. Pour the two

components, at the specified mixing ratio, into a clean mixing bucket. Mix the components with a low speed drill (400 rpm max.) until a uniform gray color is achieved without visible marbling. Apply bonding agent to both sides of the elastomeric concrete as well as both sides of the joint seal, making certain to completely fill the grooves with epoxy. With gloved hands, compress the joint seal and with the help of a blunt probe, push the seal into the joint opening until the seal is recessed approximately 1/4" below the surface. When pushing down on the joint seal, apply pressure only in a downward direction. Do not push the joint seal into the joint opening at an angle that would stretch the material. Seals that are stretched during installation shall be removed and rejected. Once work on placing a seal begins, do not stop until it is completed. Clean the excess epoxy from the top of the joint seal immediately with a trowel. Do not use solvents or any cleaners to remove the excess epoxy from the top of the seal. Remove the protective cover at the joint edges and check for any excess epoxy on the surface. Remove excess epoxy with a trowel, the use of solvents or any cleaners will not be allowed.

The installed system shall be watertight and will be monitored until final inspection and approval. Do not place pavement markings on top of foam joint seals.

Basis of Payment

Payment for all foam joint seals will be at the contract price bid for "Foam Joint Replacement w/ Saw Cut" by route type. Prices and payment will be full compensation for furnishing all material, including elastomeric concrete, labor, tools and equipment necessary for installing these units in place and accepted.

Pay Item

Pay Unit

Foam Joint Replacement w/ Saw Cut (Primary)

LF

Foam Joint Replacement w/ Saw Cut (Secondary)

LF

ELASTOMERIC CONCRETE

(9-27-12)

DESCRIPTION

Elastomeric concrete is a mixture of a two-part polymer consisting of polyurethane and/or epoxy and kiln-dried aggregate. Provide an elastomeric concrete and binder system that is preapproved. Use the concrete in the blocked out areas on both sides of the bridge deck joints as indicated on the plans.

MATERIALS

Provide materials that comply with the following minimum requirements at 14 days (or at the end of the specified curing time).

ELASTOMERIC CONCRETE PROPERTIES	TEST METHOD	MINIMUM REQUIREMENT
Compressive Strength, psi	ASTM D695	2000
5% Deflection Resilience	ASTM D695	95
Splitting Tensile Strength, psi	ASTM D3967	625
Bond Strength to Concrete, psi	ASTM D882 (D882M)	450
Durometer Hardness	ASTM D2240	50

BINDER PROPERTIES (without aggregate)	TEST METHOD	MINIMUM REQUIREMENT
Tensile Strength, psi	ASTM D638	1000
Ultimate Elongation	ASTM D638	150%
Tear Resistance, lb/in	ASTM D624	200

In addition to the requirements above, the elastomeric concrete must be resistant to water, chemical, UV and ozone exposure and withstand temperature extremes. Elastomeric concrete systems requiring preheated aggregates are not allowed.

PREQUALIFICATION

Manufacturers of elastomeric concrete materials shall submit samples (including aggregate, primer and binder materials) and a Type 3 certification in accordance with Article 106-3 of the Standard Specifications for prequalification to:

North Carolina Department of Transportation
Materials and Tests Unit
1801 Blue Ridge Road
Raleigh, NC 27607

Prequalification will be determined for the system. Individual components will not be evaluated, nor will individual components of previously evaluated systems be deemed prequalified for use.

The submitted binder (a minimum volume of 1 gallon) and corresponding aggregate samples will be evaluated for compliance with the Materials requirements specified above. Systems satisfying all of the Materials requirements will be prequalified for a one year period. Before the end of this period new product samples shall be resubmitted for prequalification evaluation.

If, at any time, any formulation or component modifications are made to a prequalified system that system will no longer be approved for use.

INSTALLATION

The elastomeric concrete shall not be placed until the reinforced concrete deck slab has cured for seven full days and reached a minimum strength of 3000 psi.

Provide a manufacturer's representative at the bridge site during the installation of the elastomeric concrete to ensure that all steps being performed comply with all manufacturer installation requirements including, but not limited to weather conditions (ambient temperature, relative humidity, precipitation, wind, etc), concrete deck surface preparation, binder and aggregate mixing, primer application, elastomeric concrete placement, curing conditions and minimum curing time before joint exposure to traffic. Do not place elastomeric concrete if the ambient air or surface temperature is below 45°F.

Prepare the concrete surface within 48 hours prior to placing the elastomeric concrete. Before placing the elastomeric concrete, all concrete surfaces shall be thoroughly cleaned and dry. Sandblast the concrete surface in the blockout and clear the surface of all loose debris. Do not place the elastomeric concrete until the surface preparation is completed and approved.

Prepare and apply a primer, as per manufacturer's recommendations, to all concrete faces to be in contact with elastomeric concrete, and to areas specified by the manufacturer.

Prepare, batch, and place the elastomeric concrete in accordance with the manufacturer's instructions. Place the elastomeric concrete in the areas specified on the plans while the primer is still tacky and within 2 hours after applying the primer. Trowel the elastomeric concrete to a smooth finish.

The joint opening in the elastomeric concrete shall match the formed opening in the concrete deck prior to sawing the joint.

FIELD SAMPLING

Provide additional production material to allow freshly mixed elastomeric concrete to be sampled for acceptance. A minimum of six 2 inch cube molds and three 3x6 inch cylinders will be taken by the Department for each day's production. Compression, splitting tensile, and durometer hardness testing will be performed by the Department to determine acceptance. Materials failing to meet the requirements listed above are subject to removal and replacement at no cost to the Department.

BASIS OF PAYMENT

The entire cost for joint repair using elastomeric concrete including but not limited to labor, maintenance, equipment, tools, and incidentals will be included in the unit prices for Joint Repair using Elastomeric Concrete. Linear feet measurement will include both sides of the joint to be repaired.

Payments shall be made under:

<u>Pay Item</u>	<u>Pay Unit</u>
Joint Repair using Elastomeric Concrete - less than 16" wide and less than 3" deep (Primary)	LF
Joint Repair using Elastomeric Concrete - less than 16" wide and less than 3" deep (Secondary)	LF

ASPHALT PLUG JOINT REPAIR AND REPLACEMENT:

(SPECIAL)

General

This work shall consist of supplying and installing a binder and aggregate system composed of specially blended polymer modified asphalt and specific aggregate placed in layers into a prepared expansion joint block-out. When properly installed, the joint system will provide a flexible waterproof bridge joint, which will allow for a joint movement of 1 inch in expansion and 1 inch in compression.

Joint material shall be hot applied, pre-mixed bituminous material that will provide a smooth riding surface and a waterproof joint. The Contractor shall prepare the surface to be repaired by saw cutting to a minimum of 20 inches wide and 2 inches in depth, per the manufacturer's specifications, or as directed by the Engineer, removing all loose material, and cleaning the area with compressed air. No repairs shall be made during periods of rain, snow, or sleet. Standing water shall be removed prior to placement of material.

Submittals

Prior to construction, the Contractor shall submit the following to the Engineer for review and approval:

- (A) Complete and detailed Shop Drawings of selected asphalt plug joint system. Shop Drawings shall include information covering the materials and their properties, installation procedures, storage and handling requirements, and Material Safety Data Sheets.
- (B) Shop Drawings for a temporary joint system if daily work is to be terminated prior to completion of installing the final approved system.
- (C) The resumes of the Contractor's staff that will be on site installing the asphalt plug joint system with manufacturer installation certifications and their experience installing the system, along with the names and telephone numbers of contact persons for recent projects where they have installed the system.
- (D) Material certifications and sampling shall be as required as per the NCDOT *Standard Specifications* Section 106.

Materials

All materials shall meet the specifications as approved by the Engineer prior to use. All components of the asphalt plug joint system shall be from one manufacturer. The manufacturer of the asphaltic plug joint shall provide evidence that a minimum of 5,000 linear feet of asphaltic plug joint, furnished by the same manufacturer and used in conditions similar to this application, have been installed and have had at least 2 years of satisfactory service.

(A) Binder Material

PROPERTY	ASTM TEST METHOD	REQUIREMENT
Asphalt Compatibility	D 5329	Pass
Bond (Non-immersed)	D 5329	Pass 3 cycles @ --20°F, 50% Pass 3 cycles @ 0°F, 100%
Penetration (Non-immersed)	D 5329	1 mm minimum @ 0 ± 2°F, 200 g, 60 sec 9 mm maximum @ 77° ± 2°F, 150 g, 5 sec
Ductility	D 113	40 cm minimum @ 77° ± 2°F
Flexibility	D 5329 (Note: Do not oven age specimen. After 24 hours at standard conditions, allow specimens to condition at -10° ± 2 F for 2 hours before testing)	Pass @ 10° ± 2°F
Flow	D 5329	3 mm maximum @ 140 ± 2°F, 5 hours
Resilience	D 5329	40% minimum @ 77° ± 2°F
Softening Point	D 36	180°F, minimum
Tensile Adhesion	D 5329	550% minimum

Safe Heating Temperature		390°F to 410°F
Recommended Pouring Temperature		360°F to 390°F

The bridge joint binder shall be a polymer modified asphalt and shall meet the following requirements when tested according to ASTM test methods:

(B) Aggregate

The specified aggregate shall be crushed, double washed, supplied in a ¾" gradation, and shall meet the following requirements:

GRADATION	
Sieve Size	Percent Passing
7/8"	95-100
5/8"	30-50
1/2"	10-30
3/8"	0-7
1/4"	-
#8	-

(C) Backer Rod

The backer rod shall be a closed cell, foam expansion joint filler, capable of withstanding the elevated temperature of the polymeric binder. The backer rod shall have the following typical physical properties using a 2 inch specimen and test method ASTM D-545:

Density	2.0 lbs/cf min.
Tensile Strength	30 psi min.
Compression	5 psi @ 25% min.
Water Absorption	0.03 g/cc by weight min.
Temperature @ 410°F	No Melting

(D) Bridging Plate

The bridging plate shall be a steel plate conforming to the requirements of ASTM Designation: A 36/A 36M, ¼ inch thick by 8 inch minimum wide, cut in 4ft to 5ft lengths. The top corners of the steel bridging plates shall be rounded prior to installation. Holes for locating pins shall be drilled on a longitudinal centerline at 12 inch intervals. The locating pins shall be 16d common steel nails minimum or equivalent.

Installation Crews

The joint system is to be installed only by factory trained and certified installation professionals with documented training. A representative of the manufacturer shall be present during the installation of the joint system.

Installation

The asphalt plug joint system shall be installed in accordance with the manufacturer's latest instructions and specifications. Manufacturer's representatives shall be present during the entire installation to ensure satisfactory results are obtained.

The installation shall be centered over the expansion joint gap as indicated on the plans with a minimum depth of 2 inches. It shall not be installed when ambient or substrate temperatures are below 40°F, when rain is imminent or as directed by the Engineer.

(A) Sawing the Joint

Sawcut and remove bituminous overlay and waterproofing membrane to the required dimensions as shown on the plans. If required, a leveling course shall be applied to concrete surfaces prior to placing bridging plates. Vertical surfaces of bituminous overlay shall be cleaned to remove all water and cutting dust.

When sawing for the installation of the plug joint, always use a rigid guide to control the saw in the desired direction. To control the saw and to produce a straight line as indicated on the plans, anchor and positively connect a template or a track to the bridge deck. Do not saw the joint by visual means such as a chalk line. Fill the holes used for holding the template or track to the deck with an approved repair material.

The joint shall be excavated using saws and pneumatic hand tools. Where possible, saws shall be set to cut the full required depth of the bituminous overlay and any membrane present. Variations in the depth of the overlay across the road should be considered to ensure, where possible, that the deck is not damaged. All debris from the excavation blockouts shall be removed to allow the full volume of new joint to be installed.

(B) Preparation of Sawed Joint for Installation

The entire blockout must be thoroughly cleaned and dried. Small debris may be removed by using compressed air. A Hot Compressed Air (HCA) Lance will then be applied throughout the length of the blockout.

Installation in concrete overlays requires sandblasting of the concrete vertical walls and adjacent deck area prior to the use of the HCA Lance application. Clean the joints by sandblasting with clean, dry sand immediately before placing the bonding agent. Sandblast the joint opening to provide a firm, clean joint surface free of curing compound, loose material, and any foreign matter. Sandblast the joint opening without causing pitting or uneven surfaces. In elastomeric concrete overlays, aggregate may be exposed after sandblasting. After sandblasting, either brush the surface with clean brushes made of hair, bristle or fiber, blow the surface with compressed air, or vacuum the surface until all traces of blast products and abrasives are removed from the surface.

If nozzle blasting is used to clean the joint opening, use compressed air that does not contain detrimental amounts of water or oil.

After cleaning the joint opening, the Engineer will thoroughly inspect the sawed joint opening for spalls, popouts, cracks, etc. All necessary repairs will be made by the Contractor prior to blast cleaning and installing the joint system, at no cost to the Department.

Spalled and defective concrete in the bridge deck shall be repaired with an approved material as directed by the Engineer prior to placing joint system materials.

(C) Plug Joint Installation

Backer rods shall be installed in expansion joint openings at a minimum of one inch depth as indicated on the plans.

The gap shall be caulked with the backer rod, allowing for the one inch of binder in the gap on top of the backer rod. Any previous caulking in place shall be removed and the surface prepared as per the manufacturer's directions for applying the new caulking. A small amount of hot binder should be placed onto the caulking to ensure that the gap is adequately plugged.

Immediately after cleaning and caulking, the entire blockouts shall be coated with a thin layer of hot binder. It shall be poured into the expansion joint openings until it runs over the edges. If significant delay occurs, the blockouts shall be inspected to determine if re-cleaning is necessary.

Binder shall be heated to a safe temperature as recommended by the manufacturer. Heating kettles shall be equipped with continuous agitation system, temperature controller, calibrated thermometer and double steel jacket with an oil layer in between, to prevent scorching of the binder. During application, the temperature of the binder shall be maintained at the minimum of 350°F.

Steel bridging plates shall be placed in the blockout and centered over the expansion joint, locating pins shall be used to secure each plate in place. Maintain at least 2 inches between the edge of the steel plate and the wall of the blockouts. Once the locating pins are in place, the top of the plate shall be coated with a thin layer of hot binder.

Aggregate shall be heated in a rotating drum mixer to a minimum of 350°F or as recommended by the manufacturer. The polymer modified asphalt binder shall be added to the mixer to precoat aggregates.

Coated aggregates shall be placed into the blockouts in layers as recommended by the manufacturer. Blockouts shall be overfilled with coated aggregate as required to compensate for compaction. Equipment for compaction shall be as recommended by the manufacturer. Additional polymer modified asphalt binder shall be screeded over the compacted joint to fill any surface voids.

Compaction shall take place as per the manufacturer's recommendations. The joint surface shall be made approximately level with the existing road surface by using methods recommended by the manufacturer.

Top dressing aggregate shall be applied per the manufacturer's recommendations.

Vehicular traffic may pass over finished joints two hours after compaction or as recommended by the manufacturer.

In the event of work stoppage while constructing a joint, a temporary joint material pre-approved by the Engineer may be used.

The Contractor shall ensure that the entire work area is clean of debris daily, prior to departure from the jobsite.

Basis of Payment

Asphalt Plug Joint for Preservation will be measured and paid for at the contract unit price bid per linear foot and will be full compensation for furnishing all material, labor, tools, incidentals and equipment necessary for installing the joint systems, with approval by the Engineer.

Payments shall be made under:

<u>Pay Item</u>	<u>Pay Unit</u>
Asphalt Joint Repair/Replacement - 18"-24" wide, w/ plate (Primary)	LF
Asphalt Joint Repair/Replacement - 18"-24" wide, w/ plate (Secondary)	LF

CONCRETE DECK & RAIL REPAIR:

Description

This provision addresses the removal, placement and finishing of concrete required for reconstructing the deck & rail if necessary, at bridge deck & rail joint locations as directed by the engineer.

Removal and Preparation

Remove existing concrete within the joint area to the limits as directed by the engineer. Existing concrete that is deteriorated, cracked or spalled shall be removed to sound material. Do not cut or remove the existing reinforcing steel unless otherwise directed.

Prior to placing concrete at rail repair locations, install a rigid form at the required grade and profile.

Completely clean all surfaces of grease, oil, curing compounds, acids, dirt, or loose debris prior to placing concrete. Thoroughly soak concrete surfaces prior to placing concrete. Remove any standing water from the repair area surface prior to placing concrete.

Materials

Furnish Department approved pre-packaged concrete or bulk concrete materials in a mix proportioned to satisfy provisions for Class AA Concrete detailed in Section 1000-4 of the *Standard Specifications* or as otherwise noted in these provisions. Concrete mix shall meet the following requirements:

Physical Property	Threshold Limitation	Test Method
Compressive Strength (at 3 hrs.)	4500 psi (min.)	ASTM C39/C109
Slump	4 in. (min.) 7 in. (max.)	AASHTO T119
Water to Cement Ratio	0.450 (max.)	N/A
Modulus of Elasticity (at 28 days)	5200 ksi (max.)	ASTM C469

Coefficient of Thermal Expansion (at 28 days)		4.5 in./in./°F (min.)	AASHTO T336
		5.5 in./in./°F (max.)	
Concrete Setting Times	Initial	30 min. (max.)	ASTM C191
	Final	40 min. (max.)	

Concrete shall be capable of placement on existing concrete substrate surfaces within the following temperature limitations:

40⁰ F (min.)

100⁰ F (max.)

Measurement for determination of concrete material compositions shall be in accordance with Section 1000-8 of the *Standard Specifications*.

Submit pre-packaged concrete mix contents or concrete mix design, including laboratory compressive strength data, for a minimum of six 4-inch by 8-inch cylinders at an age of 3 hours and 1 day to the Engineer for review. Include test results for the slump and air content of the laboratory mix. Perform tests in accordance with AASHTO T119 and T152.

Provide aggregates that are free from ice, frost and frozen particles when introduced into the mixer.

For equipment, proportioning and mixing of concrete compositions, see Section 1000-12 of the *Standard Specifications* and the Special Provision entitled “Volumetric Mixer”. Prior to beginning any work, obtain approval for all equipment to be used for joint area preparation, mixing, placing, finishing, and curing the deck repair concrete.

Placing and Finishing

Place Class AA concrete or an approved patching material to the original grade and profile of the concrete deck or rail. Provide a Class 2 finish on repaired areas. All work shall be in accordance with the current Standard Specifications for Roads and Structures.

Measurement and Payment

Concrete Repair will be measured and paid for at the contract unit price bid per square foot, by route, and will be full compensation for removal, containment and disposal off-site of unsound concrete, placement and finishing of repair concrete and shall include the cost of labor, tools, equipment and incidentals necessary to complete the repair work.

Payments shall be made under:

<u>Pay Item</u>	<u>Pay Unit</u>
Concrete Repair (Primary)	SF
Concrete Repair (Secondary)	SF

PORTABLE LIGHTING

The contractor shall furnish all portable lighting used on the project. Basis of payment will be the unit bid price under Portable Lighting per day. Any portion of a calendar day, which requires the use of portable lighting, will constitute payment for a full day.

Payments shall be made under:

<u>Pay Item</u>	<u>Pay Unit</u>
Portable Lighting	DAY

LITTER CLEANUP & REMOVAL:

Litter pick-up shall be performed on all areas. Litter pick-up consisting of construction debris, will be considered incidental to mobilization. No additional compensation will be made for litter pick-up.

EROSION, SILTATION, AND POLLUTION CONTROL:

The Contractor shall exercise every reasonable precaution and take all necessary measures throughout the life of the project to prevent erosion, siltation, and pollution in accordance with Section 107-12 of the 2018 Standard Specifications.

INSPECTION:

All work shall be subject to inspection by the Engineer at any time. Routinely, the Engineer will make periodic inspections of the completed work. It will be the responsibility of the Contractor to keep the Engineer informed of his proposed work plan and to submit written reports of work accomplished on a frequency to be determined by the Engineer.

PROPOSED WORK LOCATIONS:

Maps are available at: http://www.ncdot.org/doh/operations/dp_chief_eng/maintenance/bridge/

NCDOT INSPECTORS:

Inspectors will assist in locating and measuring quantities daily. The contractor will work with the inspector in mapping out routes weekly to advise County Bridge Maintenance Supervisors of approximate work locations.

TYPICAL SECTIONS:

Foam Joint Seal
Expansion

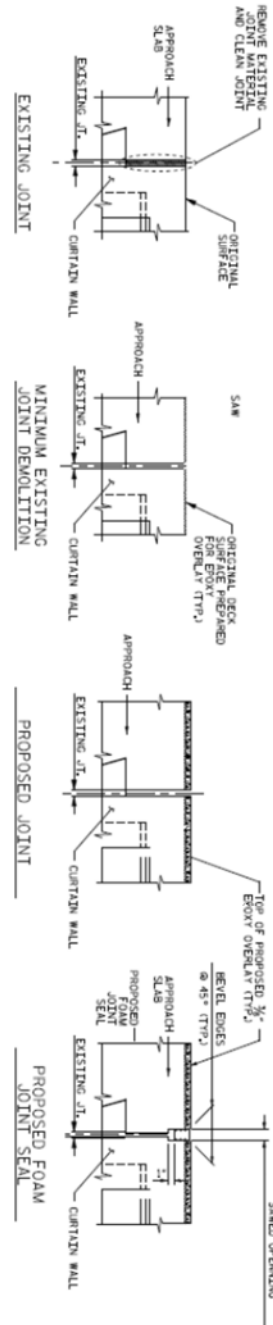

JOINT INSTALLATION SEQUENCE AT END BENTS

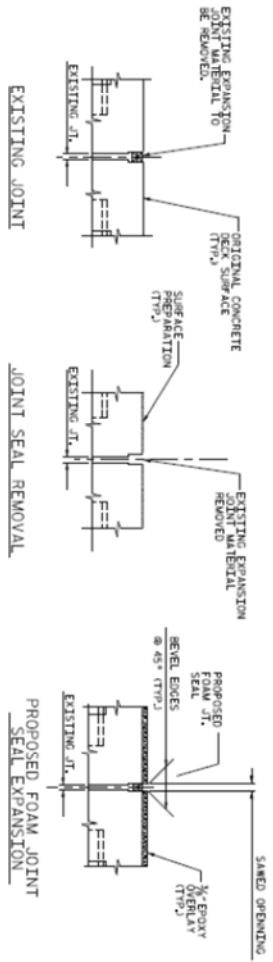

JOINT INSTALLATION SEQUENCE AT BENT

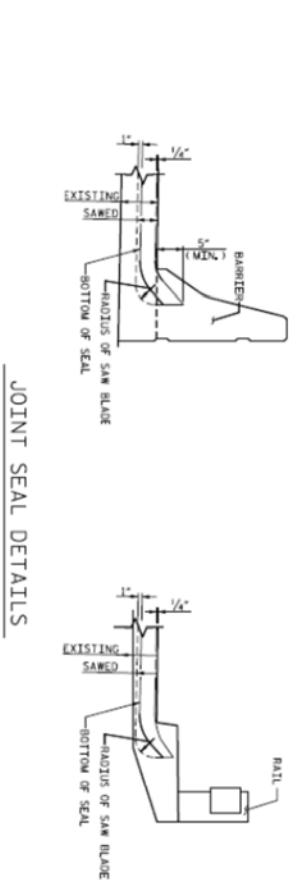

JOINT SEAL DETAILS

Joint Demolition for Elastomeric Concrete

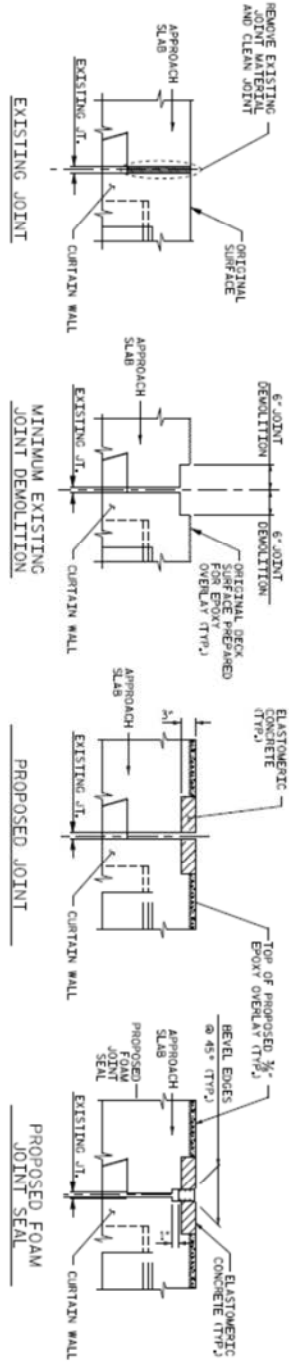

JOINT INSTALLATION SEQUENCE AT END BENTS
Requiring Joint Demolition

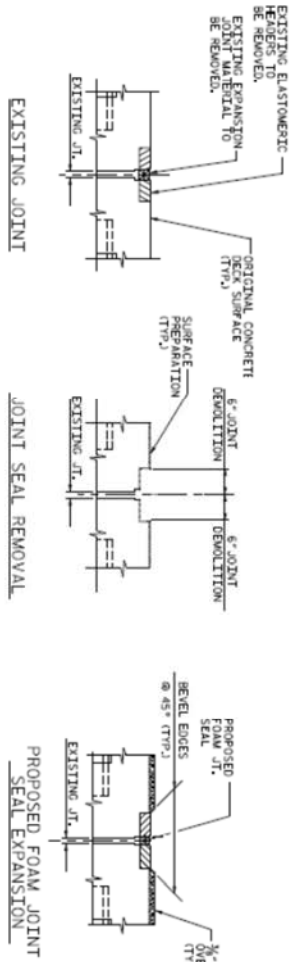

JOINT INSTALLATION SEQUENCE AT BENT #1
Requiring Joint Demolition

Asphaltic Plug Expansion

NOTES:

THE CONTRACTOR SHALL FIELD VERIFY THE EXISTING JOINT OPENING PRIOR TO ORDERING JOINT MATERIALS.

THE MANUFACTURER IS TO PROVIDE THE NOMINAL UNCOMPRESSED SEAL WIDTH OF THE BACKER ROD FOR THE EXISTING JOINT SIZE AND ACCOMODATE THE MINIMUM EXPANSION SHOWN ON THE PLANS.

ONLY APSHALTIC PLUG JOINTS THAT ARE APPROVED ON NCDOT'S APPROVED PRODUCTS LIST SHALL BE USED. CONTACT SMU PRESERVATION AND REPAIR AT LEAST 3 DAYS PRIOR TO JOINT INSTALLATION.

ASPHALTIC PLUG JOINTS SHALL BE INSTALLED AS PER THE MANUFACTURER'S RECOMMENDATIONS.

A MANUFACTURER'S CERTIFIED TRAINED REPRESENTATIVE SHALL BE PRESENT DURING THE INSTALLATION OF THE FIRST JOINT OF THE PROJECT, OR UNTIL THE ENGINEER IS SATISFIED WITH THE INSTALL PROCESS.

THE CONTRACTOR SHALL TAKE CARE DURING JOINT REHAB OPERATIONS NOT TO ALLOW ANY MATERIAL FALL BELOW THE BRIDGE. ANY MATERIAL THAT FALLS BELOW THE BRIDGE SHALL BE CONTAINED, REMOVED AND DISPOSED OF BY THE CONTRACTOR AT NO EXTRA COST TO THE DEPARTMENT. IF THE ENGINEER DETERMINES THAT THE PROTECTIVE DEVICES ARE NOT ADEQUATE OR NOT BEING EMPLOYED, THE WORK SHALL BE SUSPENDED UNTIL ADEQUATE PROTECTION IS PROVIDED.

THE CONTRACTOR SHALL NOT BE PERMITTED TO FORM THE JOINTS IN LIEU OF SAWING THE JOINT.

THE STEEL BRIDGE PLATE SHALL BE A MINIMUM OF 36 KSI STEEL. THE STEEL BRIDGE PLATE THICKNESS SHALL BE A MINIMUM OF 1/4".

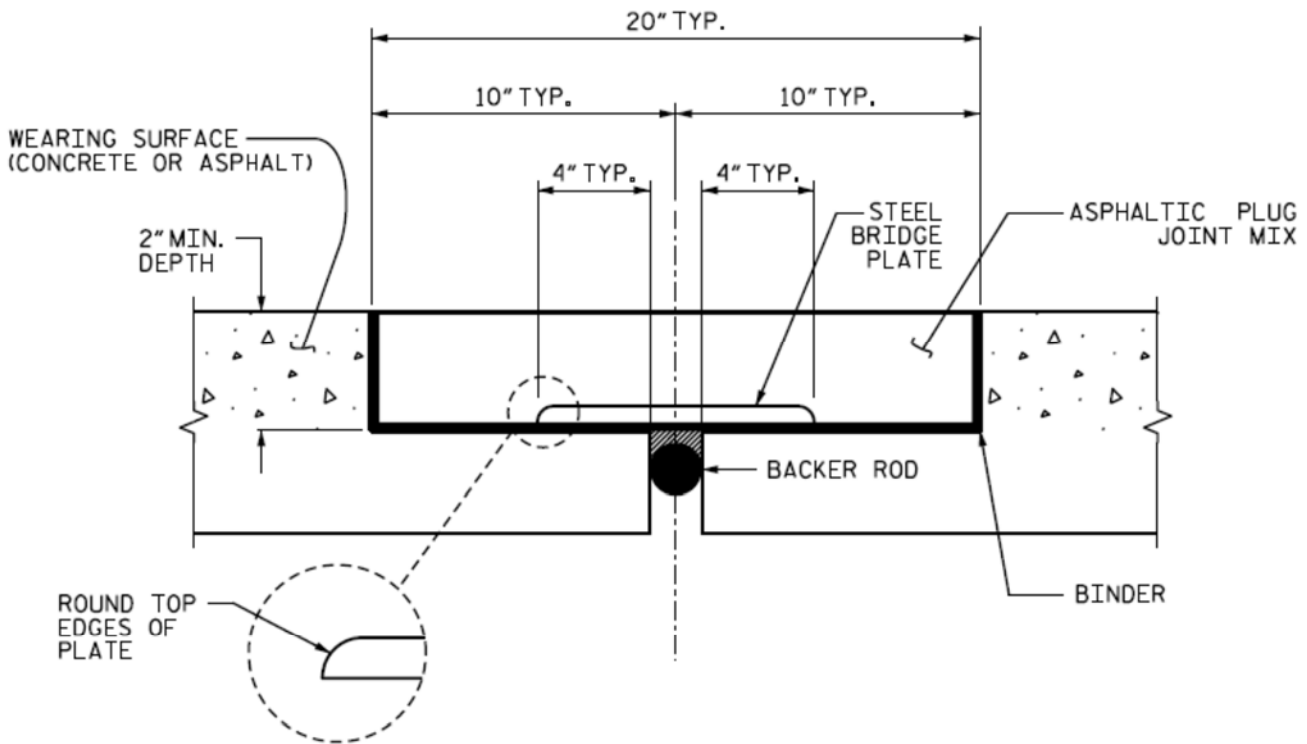

ASPHALTIC PLUG JOINT DETAIL

Silicone Expansion

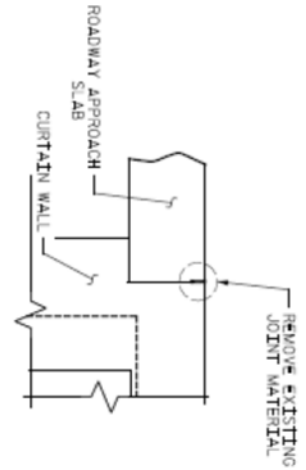

EXISTING JOINT

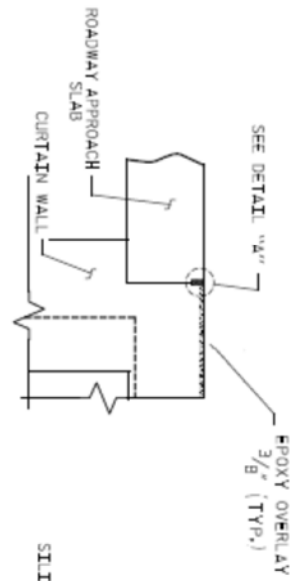

PROPOSED SILICONE JOINT SEAL

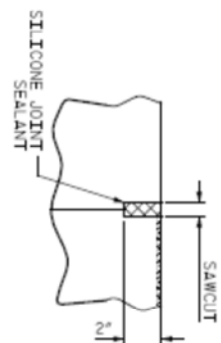

EXISTING JOINT TYPES

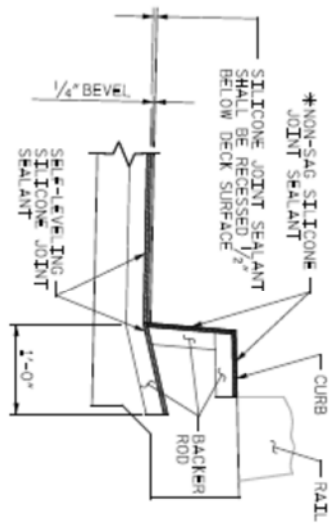

SEALING SILICONE JOINT SEALANT TO BE PLACED AND ALLOWED TO SET, PRIOR TO PLACEMENT OF NON-SAG SILICONE JOINT SEALANT.

SECTION A-A PROPOSED JOINT

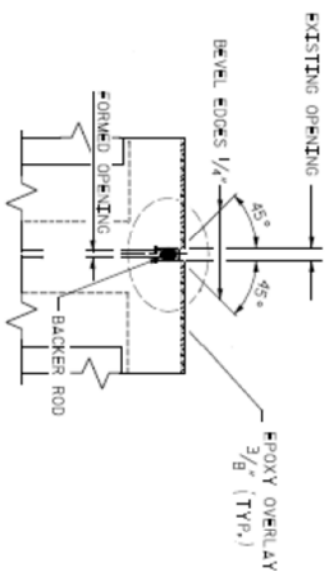

JOINT SEAL DETAILS AT END BENTS AND BENTS

PROJECT SPECIAL PROVISIONS

WORK ZONE TRAFFIC CONTROL

TRAFFIC CONTROL AND WORK ZONE SAFETY

The contractor shall maintain traffic during construction and provide, install, and maintain all traffic control devices in accordance with these project guidelines, the Project Special Provisions, North Carolina Department of Transportation Standard Specifications for Roads and Structures, and the current edition of the Manual of Uniform Traffic Control Devices (MUTCD).

The Contractor shall utilize complete and proper traffic controls and traffic control devices during all operations. All traffic control and traffic control devices required for any operation shall be functional and in place prior to the commencement of that operation. Signs for temporary operations shall be removed during periods of inactivity. The Contractor is required to leave the project in a manner that will be safe to the traveling public and which will not impede motorists.

Traffic movements through lane closures on roads with two way traffic shall be controlled by flaggers stationed at each end of the work zone. In situations where sight distance is limited, the Contractor shall provide additional means of controlling traffic, including, but not limited to, two-way radios, pilot vehicles, or additional flaggers. Flaggers shall be competent personnel, adequately trained in flagging procedures, and furnished with proper safety devices and equipment, including, but not limited to, safety vests and stop/slow paddles.

All personnel when working in traffic areas or areas in close proximity to traffic shall wear an approved safety vest, or shirt or jacket which meets the color requirements of the Manual of Uniform Traffic Control Devices (MUTCD).

The Contractor shall comply with all applicable Federal, State, and local laws, ordinances, and regulations governing safety, health, and sanitation, and shall provide all safeguards, safety devices, and protective equipment, and shall take any other needed actions, on his own responsibility that are reasonably necessary to protect the life and health of employees on the job and the safety of the public, and to protect property in connection with the performance of the work covered by the contract.

Failure to comply with any of the requirements for safety and traffic control of this contract shall result in suspension of work as provided in subarticle 108-7(2) of the Standard Specifications.

Basis of payment will be by route type and lane configuration, per each. Payment for this item will be full compensation for all installation and maintenance of traffic controls and traffic control devices and any other incidentals associated with traffic control.

Partial payments will be made on each payment estimate based on the following: Temporary traffic control work, including, but not limited to installation and removal of portable signs, cones, drums, skinny drums, flaggers, AFAD's, changeable message boards, truck mounted attenuators, flashing arrow panels, and pilot vehicles as required and used on each bridge site upon completion of all work on each bridge site.

There will be a maximum limit of 1 reimbursable closure per site.

<u>Pay Item</u>	<u>Pay Unit</u>
Traffic Control - Multi-Lane Roadway (Primary)	Each
Traffic Control - 2-Lane, 2-Way Roadway (Primary)	Each
Traffic Control - Multi-Lane Roadway (Secondary)	Each
Traffic Control - 2-Lane, 2-Way Roadway (Secondary)	Each

FLAGGERS

Provide the service of properly equipped and qualified flaggers, in accordance with Section 1150 of the Standard Specifications and *Roadway Standard Drawing* 1150.01, at locations and times for such period as necessary for the control and protection of vehicular and pedestrian traffic. Anyone who controls traffic is required to be qualified. Qualification consists of each flagger receiving proper training in the set-up and techniques of safely and competently performing a flagging operation. Qualification of flaggers is to be done by an NCDOT approved training agency. For a complete listing of these, see the Work Zone Traffic Control's webpage, <http://www.ncdot.gov/doh/preconstruct/wztc/>.

Prior to beginning work on the project, a Qualification Statement that all flaggers used on the project have been properly trained through an NCDOT approved training resource shall be provided to the Engineer.

Use flagging methods that comply with the guidelines in the MUTCD.

No direct payment shall be made for the use of flaggers, as they shall be considered incidental to other contract items.

LISTING OF MBE/WBE SUBCONTRACTORS

Sheet _____ of _____

Firm Name and Address	Circle One	Item No.	Item Description	* Agreed upon Unit Price	** Dollar Volume of Item
Name Address	MBE WBE				
Name Address	MBE WBE				
Name Address	MBE WBE				
Name Address	MBE WBE				
Name Address	MBE WBE				
Name Address	MBE WBE				

** Dollar Volume of MBE Subcontractor \$ _____

MBE Percentage of Total Contract Bid Price _____%

** Dollar Volume of WBE Subcontractor \$ _____

WBE Percentage of Total Contract Bid Price _____%

*The Dollar Volume shown in this column shall be the Actual Price Agreed Upon by the Prime Contractor and the MBE/WBE subcontractor, and these prices will be used to determine the percentage of the MBE/WBE participation in the contract.

** Dollar Volume of MBE/WBE Subcontractor Percentage of Total Contract Bid Price.

If firm is a Material Supplier Only, show Dollar Volume as 60% of Agreed Upon Amount from Letter of Intent.

If firm is a Manufacturer, show Dollar Volume as 100% of Agreed Upon Amount from Letter of Intent.

EXECUTION OF BID

**NON-COLLUSION AFFIDAVIT, DEBARMENT CERTIFICATION AND GIFT BAN
CERTIFICATION**

CORPORATION

The prequalified bidder being duly sworn, solemnly swears (or affirms) that neither he, nor any official, agent or employee has entered into any agreement, participated in any collusion, or otherwise taken any action which is in restraint of free competitive bidding in connection with any bid or contract, that the prequalified bidder has not been convicted of violating *N.C.G.S. §133-24* within the last three years, and that the prequalified bidder intends to do the work with his own bonafide employees or subcontractors and will not bid for the benefit of another contractor.

By submitting this non-collusion, debarment and gift ban certification, the Contractor is attesting his status under penalty of perjury under the laws of the United States in accordance with the Debarment Certification attached, provided that the Debarment Certification also includes any required statements concerning exceptions that are applicable.

N.C.G.S. §133-32 and Executive Order 24 prohibit the offer to, or acceptance by, any State Employee of any gift from anyone with a contract with the State, or from any person seeking to do business with the State. By execution of any response in this procurement, you attest, for your entire organization and its employees or agents, that you are not aware that any such gift has been offered, accepted, or promised by any employees of your organization.

SIGNATURE OF PREQUALIFIED BIDDER

_____ Full name of Corporation

_____ Address as Prequalified

Attest _____ By _____
Secretary/Assistant Secretary President/Vice President/Assistant Vice President
(Select appropriate title) (Select appropriate title)

_____ Print or type Signer's name _____ Print or type Signer's name

CORPORATE SEAL

EXECUTION OF BID

**NON-COLLUSION AFFIDAVIT, DEBARMENT CERTIFICATION AND GIFT BAN
CERTIFICATION**

PARTNERSHIP

The prequalified bidder, being duly sworn, solemnly swears (or affirms) that neither he, nor any official, agent or employee has entered into any agreement, participated in any collusion, or otherwise taken any action which is in restraint of free competitive bidding in connection with any bid or contract, that the prequalified bidder has not been convicted of violating *N.C.G.S. § 133-24* within the last three years, and that the prequalified bidder intends to do the work with its own bonafide employees or subcontractors and will not bid for the benefit of another contractor.

By submitting this non-collusion, debarment and gift ban certification, the Contractor is attesting his status under penalty of perjury under the laws of the United States in accordance with the Debarment Certification attached, provided that the Debarment Certification also includes any required statements concerning exceptions that are applicable.

N.C.G.S. § 133-32 and Executive Order 24 prohibit the offer to, or acceptance by, any State Employee of any gift from anyone with a contract with the State, or from any person seeking to do business with the State. By execution of any response in this procurement, you attest, for your entire organization and its employees or agents, that you are not aware that any such gift has been offered, accepted, or promised by any employees of your organization.

SIGNATURE OF PREQUALIFIED BIDDER

Full Name of Partnership

Address as Prequalified

Signature of Witness

By

Signature of Partner

Print or type Signer's name

Print or type Signer's name

EXECUTION OF BID

**NON-COLLUSION AFFIDAVIT, DEBARMENT CERTIFICATION AND GIFT BAN
CERTIFICATION**

LIMITED LIABILITY COMPANY

The prequalified bidder, being duly sworn, solemnly swears (or affirms) that neither he, nor any official, agent or employee has entered into any agreement, participated in any collusion, or otherwise taken any action which is in restraint of free competitive bidding in connection with any bid or contract, that the prequalified bidder has not been convicted of violating *N.C.G.S. § 133-24* within the last three years, and that the prequalified bidder intends to do the work with its own bonafide employees or subcontractors and will not bid for the benefit of another contractor.

By submitting this non-collusion, debarment and gift ban certification, the Contractor is attesting his status under penalty of perjury under the laws of the United States in accordance with the Debarment Certification attached, provided that the Debarment Certification also includes any required statements concerning exceptions that are applicable.

N.C.G.S. § 133-32 and Executive Order 24 prohibit the offer to, or acceptance by, any State Employee of any gift from anyone with a contract with the State, or from any person seeking to do business with the State. By execution of any response in this procurement, you attest, for your entire organization and its employees or agents, that you are not aware that any such gift has been offered, accepted, or promised by any employees of your organization.

SIGNATURE OF PREQUALIFIED BIDDER

Full Name of Firm

Address as Prequalified

Signature of Witness

Signature of Member/Manager/Authorized Agent
Select appropriate title

Print or type Signer's name

Print or type Signer's name

EXECUTION OF BID

NON-COLLUSION AFFIDAVIT, DEBARMENT CERTIFICATION AND GIFT BAN CERTIFICATION

JOINT VENTURE (2) or (3)

The prequalified bidder, being duly sworn, solemnly swears (or affirms) that neither he, nor any official, agent or employee has entered into any agreement, participated in any collusion, or otherwise taken any action which is in restraint of free competitive bidding in connection with any bid or contract, that the prequalified bidder has not been convicted of violating *N.C.G.S. § 133-24* within the last three years, and that the prequalified bidder intends to do the work with its own bonafide employees or subcontractors and will not bid for the benefit of another contractor.

By submitting this non-collusion, debarment and gift ban certification, the Contractor is attesting his status under penalty of perjury under the laws of the United States in accordance with the Debarment Certification attached, provided that the Debarment Certification also includes any required statements concerning exceptions that are applicable.

N.C.G.S. § 133-32 and Executive Order 24 prohibit the offer to, or acceptance by, any State Employee of any gift from anyone with a contract with the State, or from any person seeking to do business with the State. By execution of any response in this procurement, you attest, for your entire organization and its employees or agents, that you are not aware that any such gift has been offered, accepted, or promised by any employees of your organization.

SIGNATURE OF PREQUALIFIED BIDDER

Instructions: **2 Joint Venturers** Fill in lines (1), (2) and (3) and execute. **3 Joint Venturers** Fill in lines (1), (2), (3) and (4) and execute. On Line (1), fill in the name of the Joint Venture Company. On Line (2), fill in the name of one of the joint venturers and execute below in the appropriate manner. On Line (3), print or type the name of the other joint venturer and execute below in the appropriate manner. On Line (4), fill in the name of the third joint venturer, if applicable and execute below in the appropriate manner.

(1) _____
Name of Joint Venture

(2) _____
Name of Contractor

Address as Prequalified

Signature of Witness or Attest By _____
Print or type Signer's name Signature of Contractor
Print or type Signer's name

If Corporation, affix Corporate Seal and

(3) _____
Name of Contractor

Address as Prequalified

Signature of Witness or Attest By _____
Print or type Signer's name Signature of Contractor
Print or type Signer's name

If Corporation, affix Corporate Seal and

(4) _____
Name of Contractor (for 3 Joint Venture only)

Address as Prequalified

Signature of Witness or Attest By _____
Print or type Signer's name Signature of Contractor
Print or type Signer's name

If Corporation, affix Corporate Seal

EXECUTION OF BID

NON-COLLUSION AFFIDAVIT, DEBARMENT CERTIFICATION AND GIFT BAN CERTIFICATION

INDIVIDUAL DOING BUSINESS UNDER A FIRM NAME

The prequalified bidder, being duly sworn, solemnly swears (or affirms) that neither he, nor any official, agent or employee has entered into any agreement, participated in any collusion, or otherwise taken any action which is in restraint of free competitive bidding in connection with any bid or contract, that the prequalified bidder has not been convicted of violating *N.C.G.S. § 133-24* within the last three years, and that the prequalified bidder intends to do the work with its own bonafide employees or subcontractors and will not bid for the benefit of another contractor.

By submitting this non-collusion, debarment and gift ban certification, the Contractor is attesting his status under penalty of perjury under the laws of the United States in accordance with the Debarment Certification attached, provided that the Debarment Certification also includes any required statements concerning exceptions that are applicable.

N.C.G.S. § 133-32 and Executive Order 24 prohibit the offer to, or acceptance by, any State Employee of any gift from anyone with a contract with the State, or from any person seeking to do business with the State. By execution of any response in this procurement, you attest, for your entire organization and its employees or agents, that you are not aware that any such gift has been offered, accepted, or promised by any employees of your organization.

SIGNATURE OF PREQUALIFIED BIDDER

Name of Prequalified Bidder

Individual name

Trading and doing business as

Full name of Firm

Address as Prequalified

Signature of Witness

Signature of Prequalified Bidder, Individually

Print or type Signer's name

Print or type Signer's name

EXECUTION OF BID

**NON-COLLUSION AFFIDAVIT, DEBARMENT CERTIFICATION AND GIFT BAN
CERTIFICATION**

INDIVIDUAL DOING BUSINESS IN HIS OWN NAME

The prequalified bidder, being duly sworn, solemnly swears (or affirms) that neither he, nor any official, agent or employee has entered into any agreement, participated in any collusion, or otherwise taken any action which is in restraint of free competitive bidding in connection with any bid or contract, that the prequalified bidder has not been convicted of violating *N.C.G.S. § 133-24* within the last three years, and that the prequalified bidder intends to do the work with its own bonafide employees or subcontractors and will not bid for the benefit of another contractor.

By submitting this non-collusion, debarment and gift ban certification, the Contractor is attesting his status under penalty of perjury under the laws of the United States in accordance with the Debarment Certification attached, provided that the Debarment Certification also includes any required statements concerning exceptions that are applicable.

N.C.G.S. § 133-32 and Executive Order 24 prohibit the offer to, or acceptance by, any State Employee of any gift from anyone with a contract with the State, or from any person seeking to do business with the State. By execution of any response in this procurement, you attest, for your entire organization and its employees or agents, that you are not aware that any such gift has been offered, accepted, or promised by any employees of your organization.

SIGNATURE OF PREQUALIFIED BIDDER

Name of Prequalified Bidder _____
Print or type name

Address as Prequalified

Signature of Prequalified Bidder, Individually

Print or type Signer's Name

Signature of Witness

Print or type Signer's name

DEBARMENT CERTIFICATION

Conditions for certification:

1. The prequalified bidder shall provide immediate written notice to the Department if at any time the bidder learns that his certification was erroneous when he submitted his debarment certification or explanation filed with the Department, or has become erroneous because of changed circumstances.
2. The terms *covered transaction, debarred, suspended, ineligible, lower tier covered transaction, participant, person, primary covered transaction, principal, proposal, and voluntarily excluded*, as used in this provision, have the meanings set out in the Definitions and Coverage sections of the rules implementing Executive Order 12549. A copy of the Federal Rules requiring this certification and detailing the definitions and coverages may be obtained from the Contract Officer of the Department.
3. The prequalified bidder agrees by submitting this form, that he will not knowingly enter into any lower tier covered transaction with a person who is debarred, suspended, declared ineligible, or voluntarily excluded from participation in NCDOT contracts, unless authorized by the Department.
4. For Federal Aid projects, the prequalified bidder further agrees that by submitting this form he will include the Federal-Aid Provision titled *Required Contract Provisions Federal-Aid Construction Contract (Form FHWA PR 1273)* provided by the Department, without subsequent modification, in all lower tier covered transactions.
5. The prequalified bidder may rely upon a certification of a participant in a lower tier covered transaction that he is not debarred, suspended, ineligible, or voluntarily excluded from the covered transaction, unless he knows that the certification is erroneous. The bidder may decide the method and frequency by which he will determine the eligibility of his subcontractors.
6. Nothing contained in the foregoing shall be construed to require establishment of a system of records in order to render in good faith the certification required by this provision. The knowledge and information of a participant is not required to exceed that which is normally possessed by a prudent person in the ordinary course of business dealings.
7. Except as authorized in paragraph 6 herein, the Department may terminate any contract if the bidder knowingly enters into a lower tier covered transaction with a person who is suspended, debarred, ineligible, or voluntarily excluded from participation in this transaction, in addition to other remedies available by the Federal Government.

DEBARMENT CERTIFICATION

The prequalified bidder certifies to the best of his knowledge and belief, that he and his principals:

- a. Are not presently debarred, suspended, proposed for debarment, declared ineligible, or voluntarily excluded from covered transactions by any Federal department or agency;
- b. Have not within a three-year period preceding this proposal been convicted of or had a civil judgment rendered against them for commission of fraud or a criminal offense in connection with obtaining, attempting to obtain, or performing a public (Federal, State or local) transaction or contract under a public transaction; violation of Federal or State antitrust statutes or commission of embezzlement, theft, forgery, bribery, falsification or destruction of records; making false statements; or receiving stolen property;
- c. Are not presently indicted for or otherwise criminally or civilly charged by a governmental entity (Federal, State or local) with commission of any of the offenses enumerated in paragraph b. of this certification; and
- d. Have not within a three-year period preceding this proposal had one or more public transactions (Federal, State or local) terminated for cause or default.
- e. Will submit a revised Debarment Certification immediately if his status changes and will show in his bid proposal an explanation for the change in status.

If the prequalified bidder cannot certify that he is not debarred, he shall provide an explanation with this submittal. An explanation will not necessarily result in denial of participation in a contract.

Failure to submit a non-collusion affidavit and debarment certification will result in the prequalified bidder's bid being considered non-responsive.

Check here if an explanation is attached to this certification.

Contract No: D6BR.POC.019

County: Division Wide – Bladen, Columbus, Cumberland, Harnett & Robeson

ACCEPTED BY THE DEPARTMENT OF TRANSPORTATION

Division Proposals Engineer

Date

**EXECUTION OF CONTRACT AND BONDS
APPROVED AS TO FORM:**

Division Proposals Engineer

Date

ADDENDUM(S)

ADDENDUM #1

I, _____
(SIGNATURE)

representing _____

Acknowledge receipt of Addendum #1.

ADDENDUM #2

I, _____
(SIGNATURE)

representing _____

Acknowledge receipt of Addendum #2.

ADDENDUM #3

I, _____
(SIGNATURE)

representing _____

Acknowledge receipt of Addendum #3.

North Carolina Department of Transportation

CONTRACT BID FORM

CONTRACT NO.: D6BR.POC.019
WBS ELEMENT NO.: 6BPR.10091, ETC.
COUNTY: Bladen, Columbus, Cumberland, Harnett & Robeson
DESCRIPTION: Repair & Replacement of Bridge Expansion Joints

LINE	ITEM	SEC	DESCRIPTION	QTY	UNIT	UNIT PRICE	AMOUNT BID
10	0000100000-N	800	Mobilization (Primary)	6	EA		
20	0000100000-N	800	Mobilization (Secondary)	9	EA		
30	0000820000-N	SP	Portable Lighting	10	DAY		
40	4600000000-N	1105	Traffic Control - Multi-Lane Roadway (Primary)	3	EA		
50	4600000000-N	1105	Traffic Control - 2-Lane, 2- Way Roadway (Primary)	3	EA		
60	4600000000-N	1105	Traffic Control - Multi-Lane Roadway (Secondary)	4	EA		
70	4600000000-N	1105	Traffic Control - 2-Lane, 2- Way Roadway (Secondary)	5	EA		
80	8867000000-E	SP	Silicon Joint Replacement - Less than 1" (Primary)	50	LF		
90	8867000000-E	SP	Silicon Joint Replacement - Greater Than 1" (Primary)	50	LF		
100	8867000000-E	SP	Silicon Joint Replacement - Less than 1" (Secondary)	50	LF		
110	8867000000-E	SP	Silicon Joint Replacement - Greater Than 1" (Secondary)	50	LF		
120	8867000000-E	SP	Foam Joint Replacement w/ Saw Cut (Primary)	450	LF		
130	8867000000-E	SP	Foam Joint Replacement w/ Saw Cut (Secondary)	450	LF		
140	8867000000-E	SP	Joint Repair/Replacement using Elastomeric Concrete - less than 16" wide and less than 3" deep (Primary)	450	LF		
150	8867000000-E	SP	Joint Repair/Replacement using Elastomeric Concrete - less than 16" wide and less than 3" deep (Secondary)	450	LF		

160	8867000000-E	SP	Asphalt Joint Repair/Replacement - 18"-24" wide, w/ plate (Primary)	400	LF		
170	8867000000-E	SP	Asphalt Joint Repair/Replacement - 18"-24" wide, w/ plate (Secondary)	450	LF		
180	8892000000-E	SP	Concrete Repair (Primary)	125	SF		
190	8892000000-E	SP	Concrete Repair (Secondary)	125	SF		

*** Unit Prices Must Be Limited To Two (2) Decimal Places ***

TOTAL BID: _____

CONTRACTOR _____

ADDRESS _____

Federal Identification Number _____ Contractors License Number _____

Authorized Agent _____ Title _____

Signature _____ Date _____

Witness _____ Title _____

Signature _____ Date _____

Point of Contact for Post Bid Inquiries (e.g., Letters of Intent, Insurance, Bonds, Contract Execution, etc.):

Name _____

Email _____

Phone _____